

Humor For Those Who Don't Know Any Better

Ⓚ

GENERIC

DODO

①

An AAFES Product

CONTENTS:

8 Gut-Busting Laughs,
11 Guffaws, 13 Chuckles,
19 Grins, and Some
Artificial Additives and
Preservatives.

Best If Used By:

APR 92

EADETORES PAGE

OK, OK, so this is an April issue in May. What're you gonna do? Listen, it was not My Decision. The Censors were in a diabolical, twisted agreement with the more violent faction of the Columbian Medellin cocaine cartel. It's an ugly story, but suffice it to say that the Dodo will punish all those wrongdoers if we have to hunt them down with attack dogs and pierce their cheeks with awls to Mark them for their Wrongness. They will learn!! I am Supreme Dodo Commander! We will have no conflict with the Wing and CW; there will be no song "Should I Stay or Should I SLOW?!!" This is Malisow's Hierarchy of Needs in action: we will meet their Forms 10 with Water Cannon and Sandblasting Equipment...I assure you, Order will be restored to the Pulse of the Wing, and things will be put Right, even if we have to resort to Cannibalism...I pray it does not go that far...

Spring Break is over once more; to tell the truth, for me it was just a repeat of New Year's. Except that this time the dwarf's name was Arty, and the policeman had a strange affinity for cocker spaniels, not lobsters. Things are getting more normal.

Well, hey, a Recognition has come and gone, again. Whoopee. It came as such a surprise, we were all caught off balance. Have you noticed how the most cadets who feel '95 wasn't ready are in '94? Now there's the pot calling the kettle off-white. But the kicker was seeing the CE department put their glorious symbol on Flatiron. Boy, those DF guys sure know how to party, huh?

Now that all you freshmen are recognized, take this wonderful opportunity to run up to the fifth floor in the library and look up Washington's General Order to the Continental Army, 03 AUG, 1776. Funny thing is, there ain't no such animal; it doesn't exist, and Washington was historically known for his command of the cussing vocabulary. Kinda cute that it comes right after that thing about Lyin', Cheatin', and All That in Contrails... Oh, and by the way, the Medal of Honor really isn't given by an Act of Congress, it's given in the name of Congress, that's how it got the nickname. Remember the Dodo never lies, and we are ALWAYS right, so don't even bother arguing. So believe it when we tell you that 2^o won't have cars next year and we can't go out on Saturdays anymore....

I celebrated my 21st a little while back (so did Toke, we share the same Air Force Day with Shannon Dougherty). My friends (both of them) tried their best to get me to ruin my Docksides (successfully). I had, in the span of 80 minutes, a Prarie Fire, a Modified Snakebite, two MGD's (I'm from Milwaukee), a Cement Mixer (Satan's Gift to drinkers), a Long Island Iced Tea, and a Mat Shot, the drink which proves that even bartenders have a sense of humor. It's good to be mature and dignified enough to drink.

A simple problem the Wing now faces is the full value of the Dry Cleaning Mandate. Why doth thou complainst? Those that are loudest in lamentation are them that do not send anything out! Hell, send out your comforter every week!! Don't make it easy on the weasels, send out the macrame pillowcase your mom made for you! Send out all your flight caps- they are Free! Swamp these rodents with more laundry than they've seen this side of China. Hey, if someone's getting kickbacks, let's at least make it difficult for 'em.

On a very rare serious note: This one is for Buffy, because even as we made the toast, we knew it was far too early. There will always be a part of you here with us, and us with you.

QUOTE O' THE MONTH: "ISN'T IT IRONIC THAT WE SPEND FOUR YEARS HERE LEARNING TO BECOME THAT WHICH WE DESPISE."

- JIM EBEL

(2)

THE STARS OF THE NEW MOVIE...

THE GOOD... THE BAD... AND THE DODO.

STARRING: NINO BALDACC

* BEN 'SLOW' MALISON

Tim "CAPTAIN" KIRK

Cousin Dave Nicklas

K.C. BROOKS

DAN "TOKE" CARROLL

AS HIMSELF

JONATHAN "TRASHMAN" BOYD

TIM "VITO" VITUSZYNSKI

MARK "MARTIAN" HANSON

JOHN "BAZ" BASMAJIAN

Jim Engle

CHASE "GRIN 'N" BARRETT

DENNIS "BONE" BONILLA

Brent "The Gooch" Helinski

MARK "WOMBAT" PIPER

TREVOR RUSH

DAN "BEAKER" BOURQUE

MARSHALL "GROVER" GROVES

Steve "Dodger"

MONTE "MONSTER" ANDERSON

KEY GRIP, GAFFER, BEST BOY, BOOM OPERATOR, ASSISTANT TO THE GIRL WHO PLAYS THE SCHOOL MARM
Clint Eastwood look alike.

Horse trainer and Executive Pooper Scooper
CLINT EASTWOOD STUNT DOUBLE

OFFICIAL HORSE ~~PICKER-UPPER~~

GUY WHO GETS STOT AND FALLS OFF ROOF OF GENERAL STORE

HE LEFT EARLY

That unknown kung-fu hero w/ this name I should still be on my stuff
Hero's Sidekick

TOWN BANKER WITH THE FUNNY SPECTACLES

MEXICAN WITH A SOMBRERO ASLEEP IN THE CORNER

Dennis' Role model WAY TOO COOL TO SIGN HIMSELF

OR NOBODY

Banjo Man TVOT A MUPPET The Fall Guy

BLACK HAT, BLACK BOOTS

3

First Annual Official Dodo Subscriber Survey

Personal Information (not subject to the Privacy Act):

name _____ CS- _____ room# _____

when is there no one in your room? M-days: _____

T-days: _____ weekends: _____

bed unit: _____ right _____ left. lock combinations: computer

cabinet _____ drawer _____ what valuables do you

keep in there? (please list all major items and estimated

value at a pawn shop) _____

what kind of car do you drive? _____

where do you keep the keys? _____

Survey:

1. What is your overall opinion of the Dodo? (check one)
_____ excellent _____ fantastic _____ it's why I stay at USAFA

2. What does the Dodo need to do more of?
_____ rip on training _____ rip on DF _____ rip on CW

3. Who is your favorite Dodo cartoonist?
_____ Mark Hanson _____ "Martian" _____ that 4 degree from Texas

4. How much should be taken from your paycheck for the Dodo?
_____ \$5.00 _____ \$540.00 _____ as much as the Dodo staff wants

5. About what percentage of Dodo features do you understand?
_____ 30% _____ 3% _____ none _____ I guess I understand them,
they're just stupid, especially this survey

6. What do you think of morning meal formation and SAMIs?
_____ @\$#@%^?!@*&

Please enclose a generous contribution and return through
distro to: C4C Hanson, Official Pollster, CS-06. If not
enclosing a generous contribution, that address is: Mr.
Cordova, c/o Vandenberg Dorm Management Office, Department
of Janitorial Services, Director of Trash Disposal



HEY JOE,
WHAT SAY WE
MARCH TO LUNCH

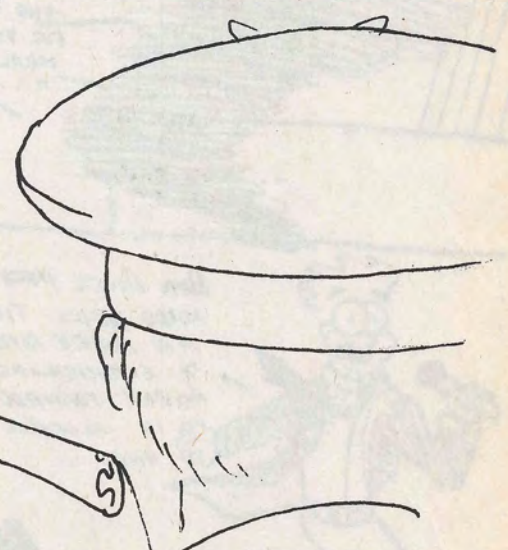
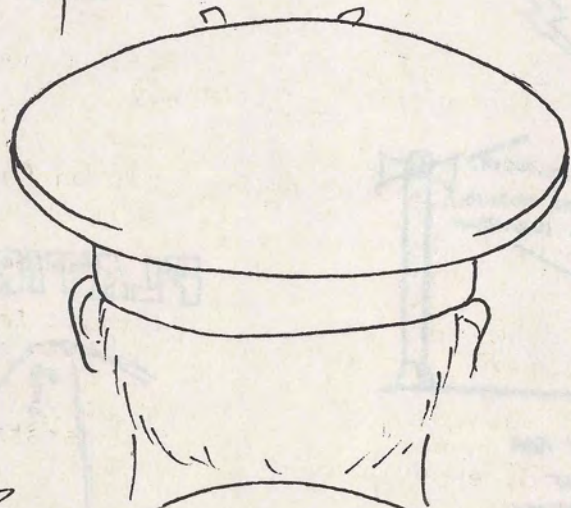

Chase Barnett '92
and the booch

PRESENTS



MELVINS CAN'T JUMP



Chris Nolan

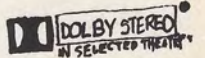

WELL, KIDS, WHEN I WAS AT THE ACADEMY MY SQUADRON WAS 1ST IN MILITARY PERFORMANCE. WE MARCHED WELL, WE KEPT OUR ROOMS SPIC & SPAN, WE WROTE LOTS OF FORMS. 10...



REMO JAKE

WHAT A BONE HEAD!

OH, BY THE WAY, I HATE GRANDPA!

THAT DON'T DOES IT REALLY MATTER?



FLATIRON:



(CLASS OF 1995 RECOGNITION DATE)



6

THE UNIFORM FOR THE MORNING MEAL FORMATION IS...

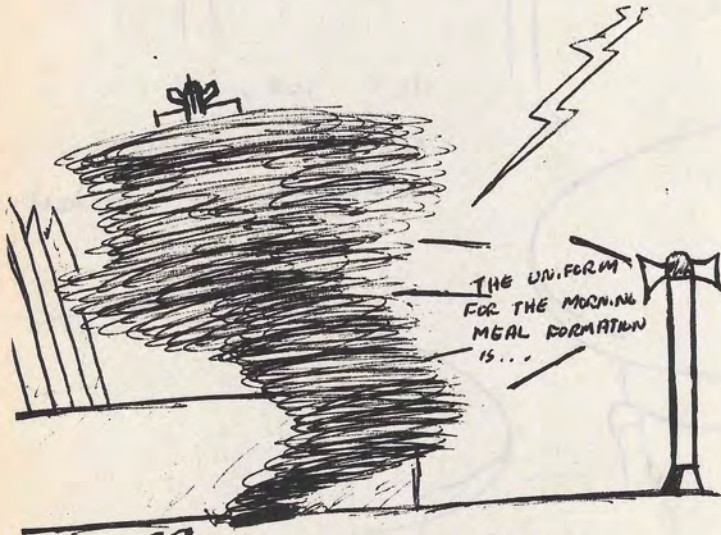

BEN COVER HERE FOR KRDD NEWS. THE AIR FORCE ACADEMY IS EXPERIENCING THE WIRIST TORNADO STORMS IN COLORADO HISTORY AND...



KG 74

IOEN DAVE DICK

WELL!
WHOA!
THEY CENSORED
DIS WHOLE
X!#@ ARTICLE!
CAN YOU BUY THAT?
UN-BE-LIE-VABLE!



Jack B.
DODO SPEAKSMODEL

WHERE'S THE DEFERRED '92 GRAD?

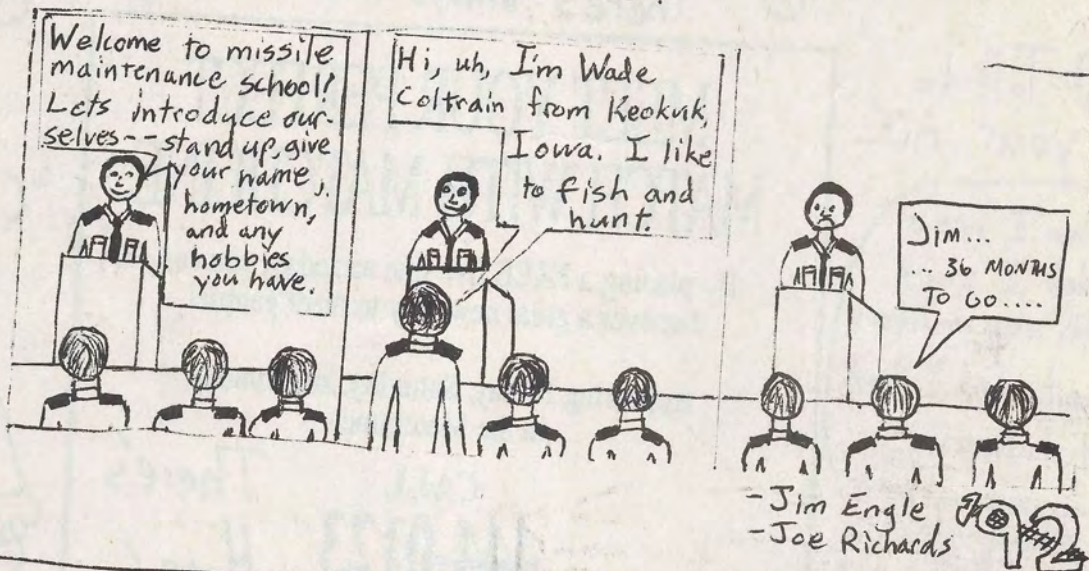

!!! Class of '93

Ring Dance
Date Alternatives



You mean I can't take Hobbes?!

① Let KAFA DJ's help!



Ok all of you AFA groupies, The next 30 callers get ring dance dates and a tape by "Lords of Acid."

HURRY!
There's still Time!

② There's always the GT... →

③ Talk to your AOC.

When I was a cadet I stuck with my military family and I took my mother.



MEET YOUR PERFECT MATCH WITH MATCHLINE.

By placing a FREE five line ad today, you can discover a great new way to meet people!

Appearing Friday, Saturday, and Sunday in the Matchline.

CALL 444-0123

There's Hope!
(maybe)

GAZETTE TELEGRAPH Classified

MatchLine

ACW

④ Try your Sponsor's daughter...
(the cradle)



⑤ Don't Forget...

AIR ACADEMY HIGH.



CONNECT THE DOTS TO SEE WHAT JOHNNY WILL BE FLYING NEXT YEAR:



3.
4° 12 9° 8 5 1

11° 10° 7° 6°
FAB

'95 RECOGNITION '95

CONGRATULATIONS, '95,
YOU'VE EARNED
IT!



twinkle

KC

The Adventures of
GAG FRED DAMUTH

a week before prog:

You know, sir,
I've really
been think-
ing of declar-
ing a Chem
major

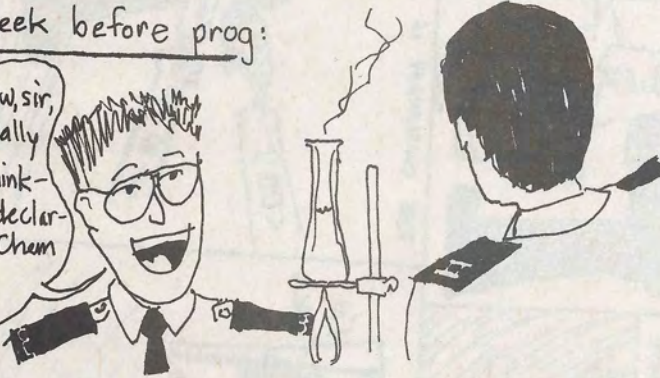

Whoa, buddy, don't doze off.
This history teacher makes
SE Asia
come to
life!



stag. even
sin

You know, mathematics, rightly
viewed, has a beauty, cold and
austere, like that of sculpture

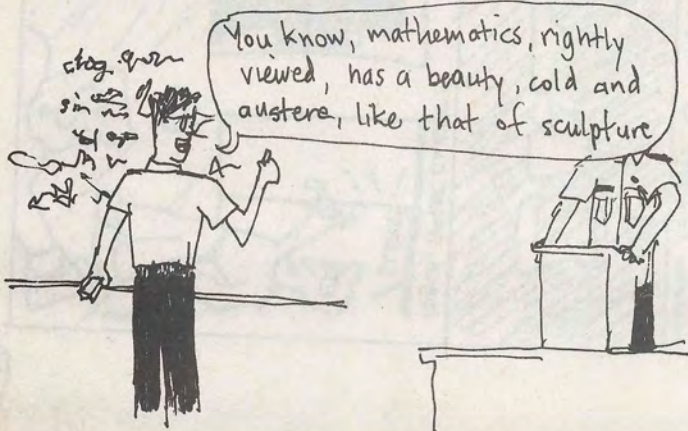

at prog

all that
work for
nothing!



CMH

IT CAME ON A DARK SATURDAY NIGHT FROM DEEP IN THE BUSHES...



THE MASHINATOR

COLD... CRUEL... LIFELESS.



AS HE LEAVES THE MASHINATOR MESS BEHIND, ULTRA SENSITIVE INFRA-RED VISION SPOTS ACTIVITY ON THE FIELDS...

ALCOHOL CONTENT: 0.5 TERMINATE



QUICK INTO THE CLOSET!



SLAM!
I'M BACK

SEARCH MODE:



POS IDENT: CABOBT, CIV FEMALS

POSSIBLE ACTIONS:

- LEAVE
- GREET
- WARN
- TERMINATE

ATTACK MODE:

IN DESPERATE NEED OF MEDICAL ATTENTION HE HEADS INTO THE DORM BUT GETS SIDE TRACKED...

SEARCH MODE: X-RAY



PROBABILITY: ALCOHOL 1.0 FEAT 1.0 PROMOTION 0.0

TERMINATE:

ONCE AGAIN VICTORIANS, HE STOPS FOR A LOT CHECK, BUT MEETS RESISTANCE...

HEY, D.I.!



100-100 FOR YOU AND A CDB FOR YOU.

YOU CAN'T SHACK DO WRONG. THAT!



SEARCH MODE:

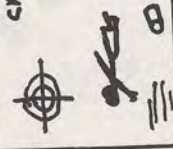

CABOBT 0.0

HIS MISSION ACCOMPLISHED, HE DOES ONE MORE LOT CHECK...

GIVE ME YOUR NAMES.



SEARCH MODE: X-RAY



PROBABILITY: ALCOHOL 1.0 FEAT 1.0 PROMOTION 0.0

TERMINATE:

NOW YOU'RE IN TROUBLE MISTER...

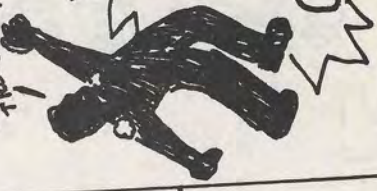

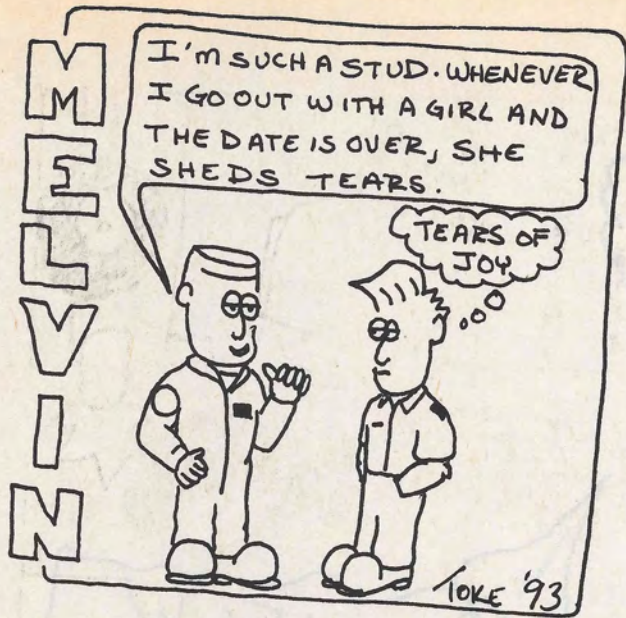

Where are they today . . . ?

2LT. Carson Tavenner - CW Gopher

More Coffee Sir?

(ex - DODD ed. to -)

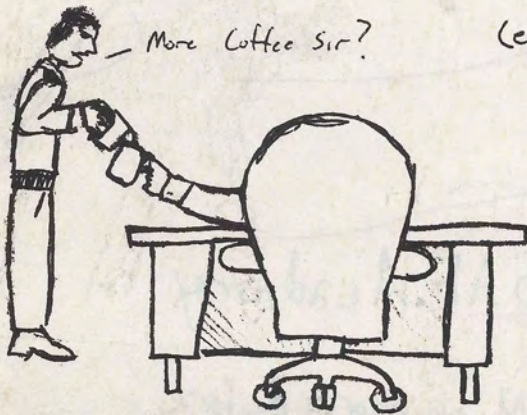

He now serves the men he used to make fun of.

Vito

HELLO, IS THIS THE BOBBIT HOTLINE?
YES, COULD YOU TELL ME WHAT SHE HAS DONE TO MY SON RECENTLY?



THANKS TO: ALL OF 16th SQUADRON

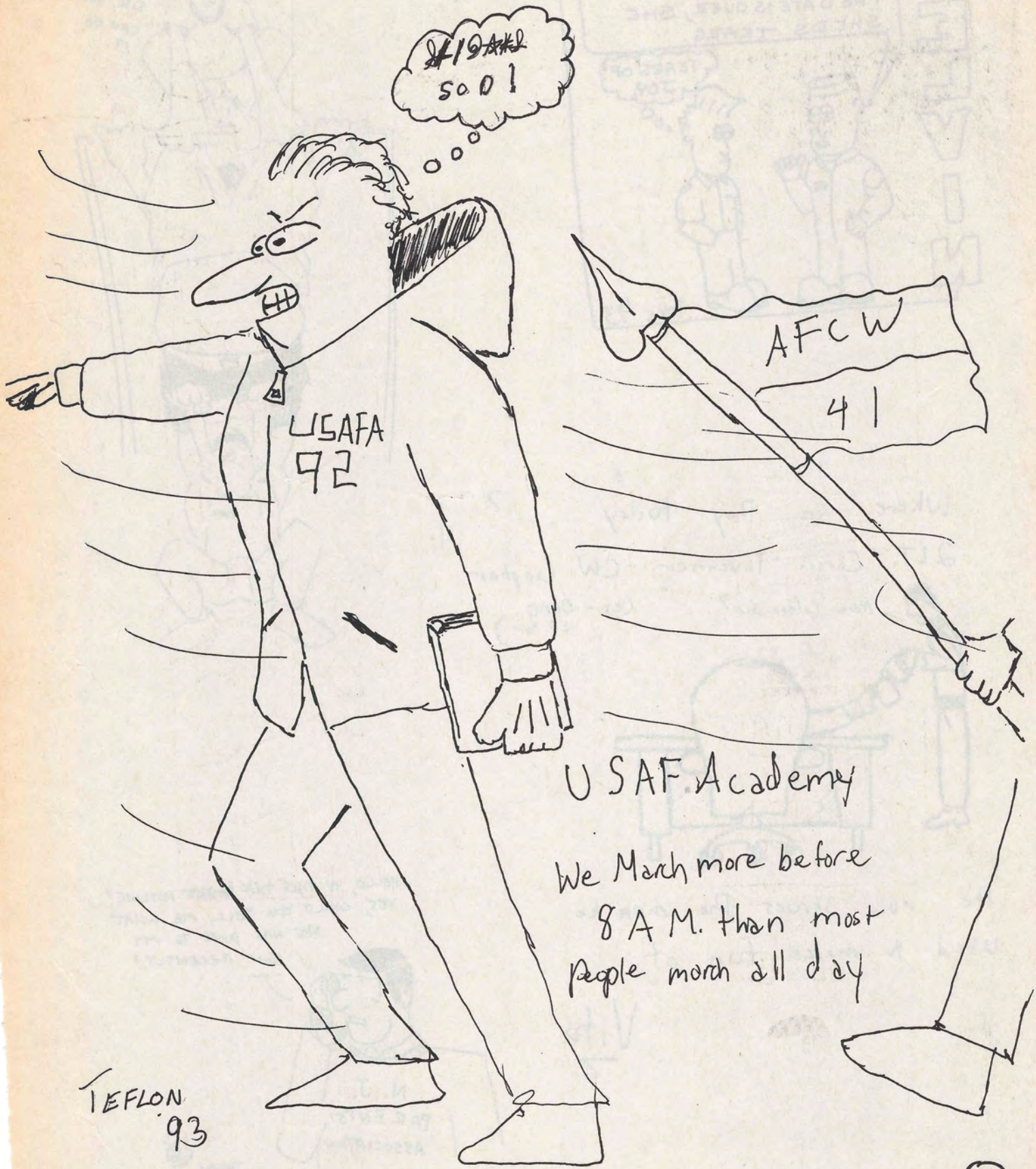

TEFLON
93

USAF Academy
We March more before
8 A.M. than most
people march all day

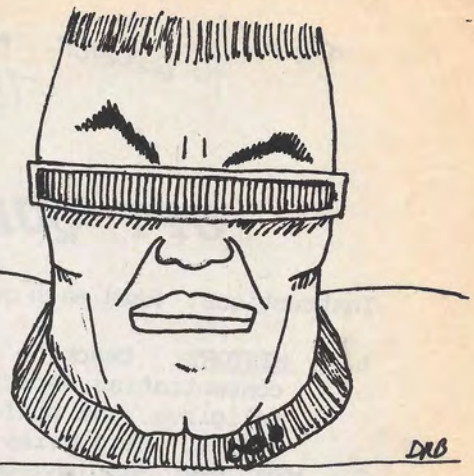
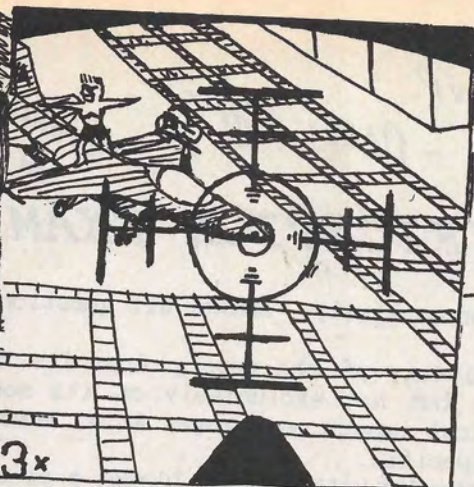

TO THE UNAIDED EYE

3x TO THE NEW UPGRADED WING STAFFER WITH FLIR

LET'S SEE THOSE SMACKS BEAM OUT OF THIS ONE

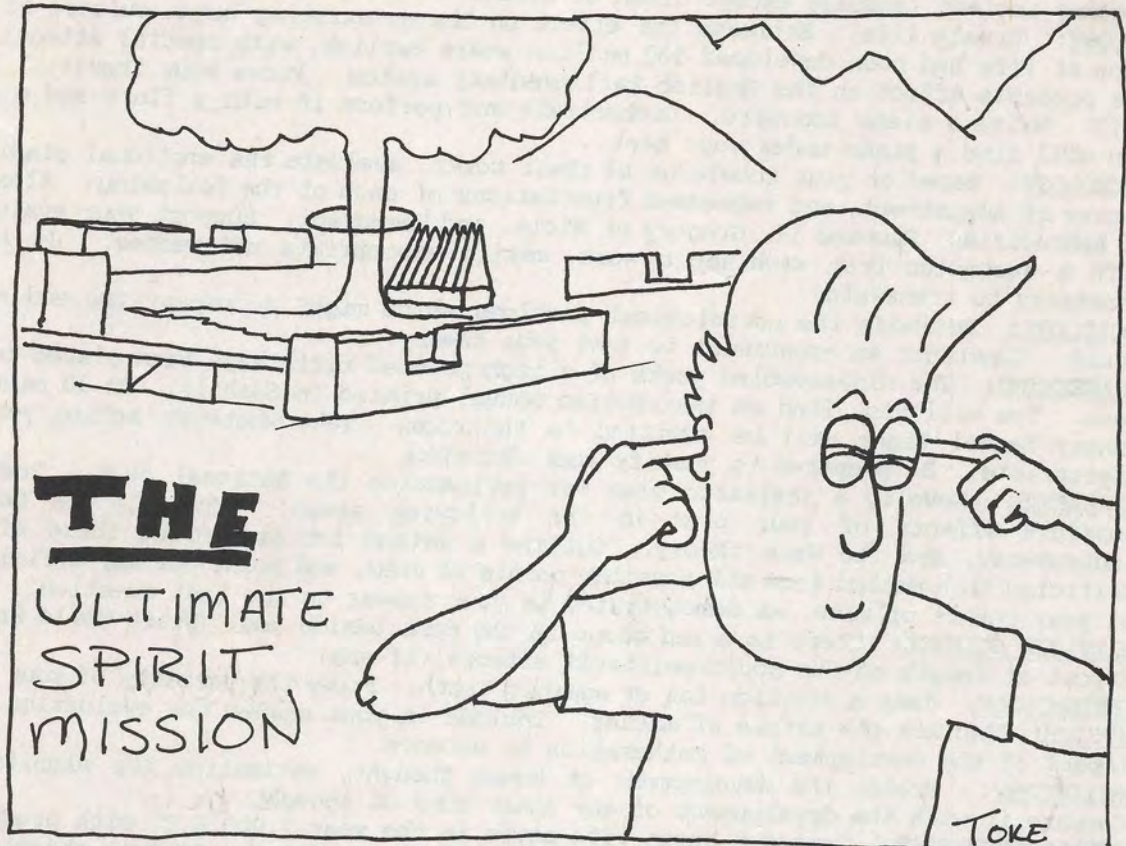

THE
ULTIMATE
SPIRIT
MISSION

TOKE

HE'S BIG... HE'S BACK... ...AND HE'S BEEN PROMOTED!!

LT COL AMERICA



...THE ONLY LT COL AOC IN THE WING!



THANKS
TO WHOEVER MADE
THIS UP.

- DODO STAFF

ACTUALLY, IT RAN
IN THE LOG YEAR... LAST
ON, WELL!
-SLOW

UPT QUALIFICATION EXAMINATION

Instructions: Read each question carefully. Answer all questions. Time limit is one hour.

1. **HISTORY:** Describe the history of the papacy from its origin to the present day, concentrating especially, but not exclusively on its social, political, economic, religious, and philosophical impact on Europe, Asia, America (North and South), and Africa. Be concise and specific.
2. **MEDICINE:** You have been provided with a razor blade, a piece of gauze, and a bottle of Scotch. Remove your appendix. Do not suture until your work has been inspected. You have 15 minutes for this part of the examination.
3. **PUBLIC SPEAKING:** 2,500 riot-crazy Aborigines are storming the classroom. Calm them. Use any ancient language except Greek or Latin.
4. **BIOLOGY:** Create life. Estimate the effect on the co-existing human culture if this form of life had been developed 500 million years earlier, with special attention to its probable effect on the English Parliamentary system. Prove your thesis.
5. **MUSIC:** Write a piano concerto. Orchestrate and perform it with a flute and a drum. You will find a piano under your seat.
6. **PSYCHOLOGY:** Based on your knowledge of their works, evaluate the emotional stability, degree of adjustment, and repressed frustrations of each of the following: Alexander of Aphrodisias, Rameses II, Gregory of Nicaea, and Hammurabi. Support your evaluation with a quotation from each man's work, making appropriate references. It is not necessary to translate.
7. **SOCIOLOGY:** Estimate the sociological problems which might accompany the end of the world. Construct an experiment to test your theory.
8. **ENGINEERING:** The disassembled parts of a high-powered rifle have been placed on your desk. You will also find an instruction manual printed in Swahili. In 10 minutes a hungry Bengal Tiger will be admitted to the room. Take whatever action you feel appropriate. Be prepared to justify your decision.
9. **ECONOMICS:** Develop a realistic plan for refinancing the National debt. Trace the possible effects of your plan in the following areas: Cubism, the Donatist controversy, and the Wave theory. Outline a method for preventing these effects. Criticize this method from all possible points of view, and point out any deficiencies of your points of view, as demonstrated in your answer to the last question.
10. **POLITICAL SCIENCE:** There is a red phone on the desk beside you. Start World War III. Report at length on its socio-political effects, if any.
11. **EPISTEMOLOGY:** Take a position for or against truth. Prove the validity of your stand.
12. **PHYSICS:** Explain the nature of matter. Include in your answer the evaluation of the impact of the development of mathematics on science.
13. **PHILOSOPHY:** Sketch the development of human thought, estimating its significance. Compare it with the development of any other kind of thought.
14. **GENERAL KNOWLEDGE:** Contrast human life-style in the year 2,000 B.C. with predictions of human life-style in the year 4,000 A.D. Describe in detail. Be both objective and specific.
15. **THEOLOGY:** Assume Catholicism had originated in Hawaii; Methodism in Bolivia; and Buddhism in Salt Lake City. Estimate the impact this would have had on: a) polygamy, b) idolatry, and c) separation of church and state. Concentrate on the socio-economic and political aspect.
16. **ASTROLOGY:** Describe the universe. Give three (3) examples.

If you complete the examination prior to the allotted time, use the remaining time to recheck your paper.



"... Originally started in CS-38, can now be available to all who suffer from uptight AOC abuse!"

Finally...

YOUR LIFE MAY DEPEND ON IT
for your safety, and security

DEFIANCE

Female approved by U.S. Government for use by Post Office personnel

only \$19.99

YOU NEED ONE!
• Pocket or Pouch
• Night Stand
• Glove Compartment

LEGAL PROTECTION FOR YOUR PEACE OF MIND
For Delivery Call CS-16 ext. 4675
Free key chain with purchase

-Dawn MUZYK

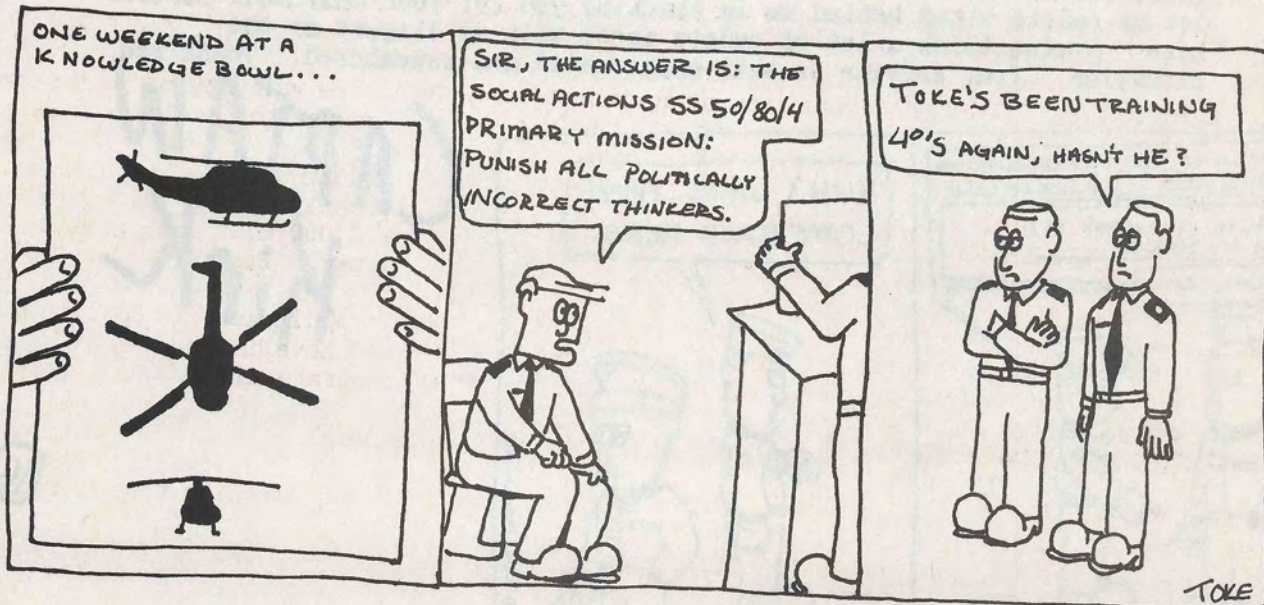

A SAD EPITAPH....

An announcement was made recently regarding the Cadet Wing Hostess Office, yes, that's right, those fine folks over in Arnold Hall who have been struggling since 1955 to try to transform cadets into civilized and respectable ladies and gentlemen. The announcement came that the Cadet Wing Hostess Office will be a victim of budget cutbacks and, as of the end of May, will be no more. Cinda Sue Thorhauer and her staff will no longer be available for advice and help for future officers. How does the Air Force plan on providing the proper training for USAFA's "Officer and Gentleman" (or Lady)? According to the Rocky Mountain News, "Academy Spokesman Will Keterson said cadets will be coached in manners and decorum by the academy's staff officers and their spouses." (Scha, and monkeys could come flying out [redacted]!) I can see it now... "Okay folks, today in M-5, my wife Yvonne is here to teach you a little about dressing for success, German cooking, diamond purchase and folk dancing... and please, think of her as your 'mother-away-from-mother'" As all the cadets think, "Yeah, okay Major Clark!" Or even Captain Paraska donning her leather pumps to instruct cadets on the finer points of ballroom dancing.

It seems to me that if some budget cutting had to be done in the Air Force, they would start with things that actually do some good. Okay, okay, I realize that not every cadet goes through the program, but I'm sure that Cinda Sue and her compatriots have made a dent in the social ineptitude of a lot of cadets... or at least have made them aware of it!

I'm mad, folks. Cadets have very few people who spend 100% of their time trying to assist cadets rather than pimping them!

There have been three Hostesses here at USAFA since 1955. Cinda Sue has been here with her staff for many years and I think they deserve a better shake than, "Sorry, Cindy. We need more terrazzo blocks on the north side of the Gymnasium, you're gone!" Budget cuts, sch! Why not try turning off the lights in Mitchell Hall at night... wow, that might save a few duckets!

Enough of my whining. I just want to offer my personal salute to those in the Cadet Wing Hostess office. Mrs. Thorhauer, I believe that a lot of cadets stand behind me in thanking you for your dedicated service here. I also think a lot of cadets agree with my disgust at the situation. Your service is well appreciated and remembered. Thank you.



CAPTAIN Kirk

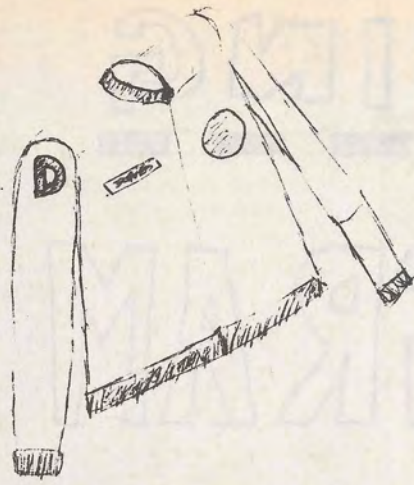

Jim Fogle

HEY! DEFERRED PILOTS! TIRED OF HEARING PEOPLE COMPLAIN ABOUT THE UPT START DATE THEY GET STUCK WITH? LET 'EM KNOW HOW YOU FEEL WITH THE ONLY NEW A-SACKET PATCH APPROVED BY THE DODC STAFF. THIS "D" FOR DEFERRED PATCH WILL KEEP PEOPLE FROM PUTTING YOU IN AWKWARD AND EMBARRASSING SITUATIONS (SUCH AS TRYING TO EXPLAIN WHY YOU ARE SURROUNDED BY BLOODY CORPSES IN FAIRCHILD)

ONLY \$4.95

(AVAILABLE ONLY IN SCARLET)



Hoster
IDEA: JJ

Why we're not allowed to have pets at the Academy...

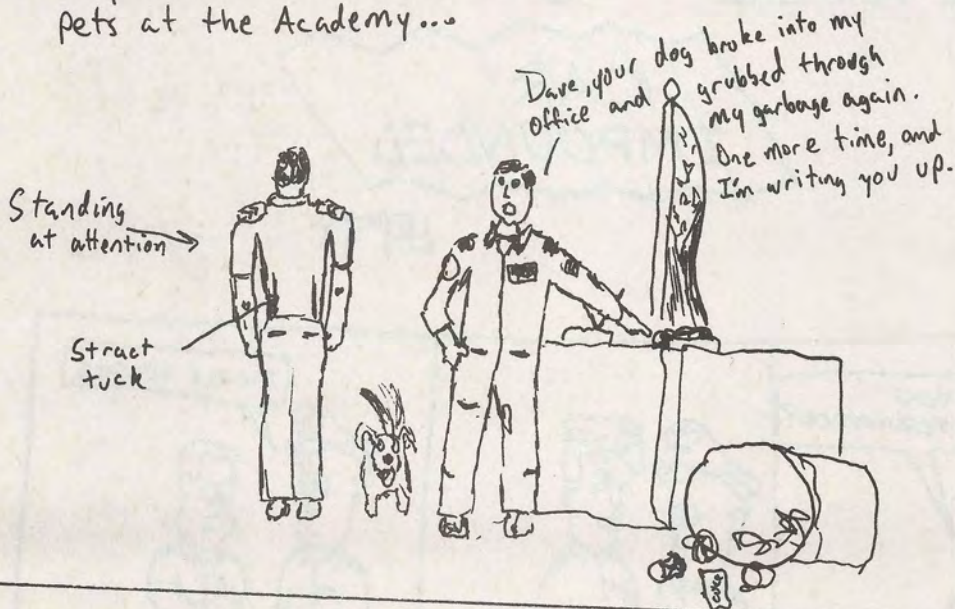

Cousin Dave.

INTRODUCING

(THE ALL-NEW)

FOLD-A-GRAM

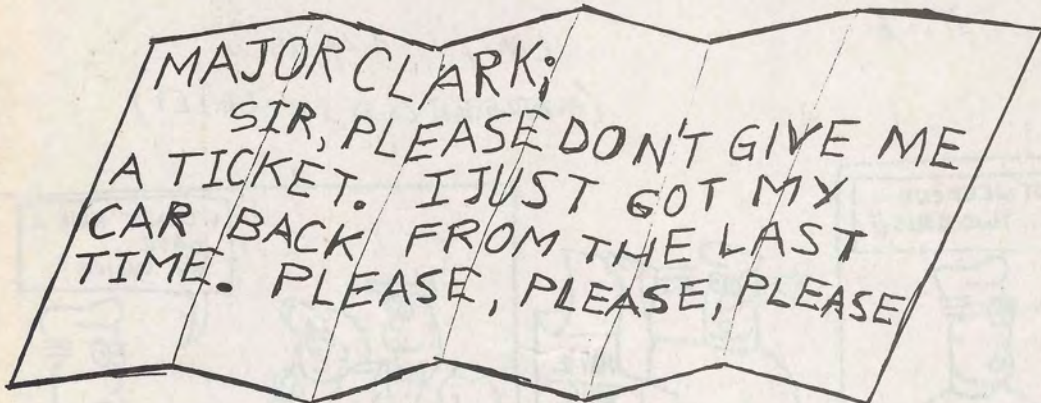

- GREAT FOR ...
 - UNLOADING SKIS UNDER VANDY
 - RESERVED PARKING AREAS
 - TOW AWAY ZONES
 - TRAINING SATURDAYS
- DUAL-PURPOSE FLIP SIDE



LEFTY



PEOPLE WITH FAR TOO MUCH



A JEDI'S POWER FLOWS FROM THE FORCE...



YES! ITS A NEW COURSE OFFERING - THE FORCE 110!

I AM NOT LATE TO CLASS... HAVE A SEAT...



YOU ARE NOT LATE TO CLASS... HAVE A SEAT...

LEARN THE JEDI MIND TRICK!

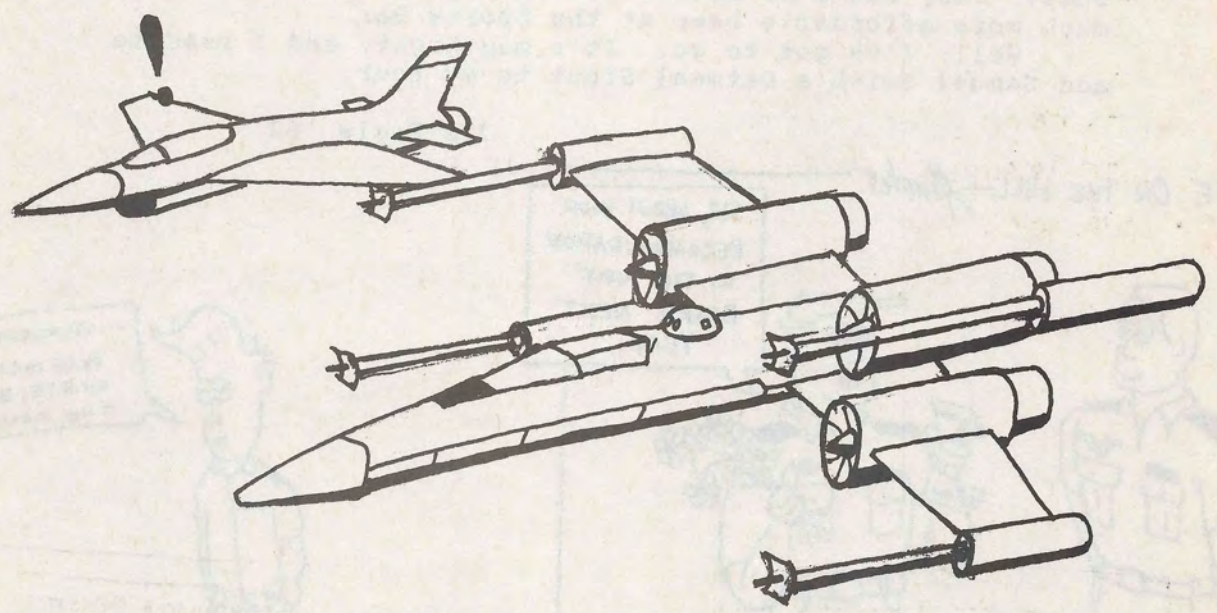

... AND, IF YOU'RE PILOT QUALIFIED AFTER GRADUATION, YOU MIGHT EARN A SPOT IN REBEL U.P.T. !

GRAVER

PEOPLE WITH FAR TOO MUCH

A few nights ago some of my friends wanted me to go with them to Old Chicago's for a couple of beers. I was about to join them, when suddenly I realized that the whole concept of the World Beer Tour is really idiotic. Cadets go to Old C's and spend over \$400 to complete the tour, and what do they get for their efforts? A mug that says Old Chicago's on it (so they can remember where all their money went), a book on beers of the world (which they don't need since they've had one of every beer in the world by the time they finish the tour), an Old Chicago's gym bag that they can bring their empties back in (just so they can hide them in low-val), and a chance at immortality by having their name emblazoned on a plaque that they don't even get to take home. If cadets are really serious about not getting paid enough money, they should stop going to Old C's and buying the \$7.95 Chimay.

Some of the names of these beers really makes me think twice about wanting to drink them. Swinkles sounds like something you do after you drink beer. Grolsch sounds like the reaction of the guy next to you in the bathroom after you drink too much beer: "Ooh, thatsh jusht grolsch, man!" Then there's John Courage. Is courage what it takes to get this one down? I'm not even going to ask where they get Buffalo Gold, Carlsberg Elephant Malt, Aass Bokk, or Young's Ram Rod.

I wonder what makes these cadets think that they have to drink a beer that's darker than used motor oil and tastes only marginally better. Is it some kind of rite of passage? Do they have something to prove? Do they have no taste buds? They would be better off saving their money to buy much more affordable beer at the Sports Bar.

Well, I've got to go. It's mug night, and I need to add Samuel Smith's Oatmeal Stout to my tour.

Jim Engle '92

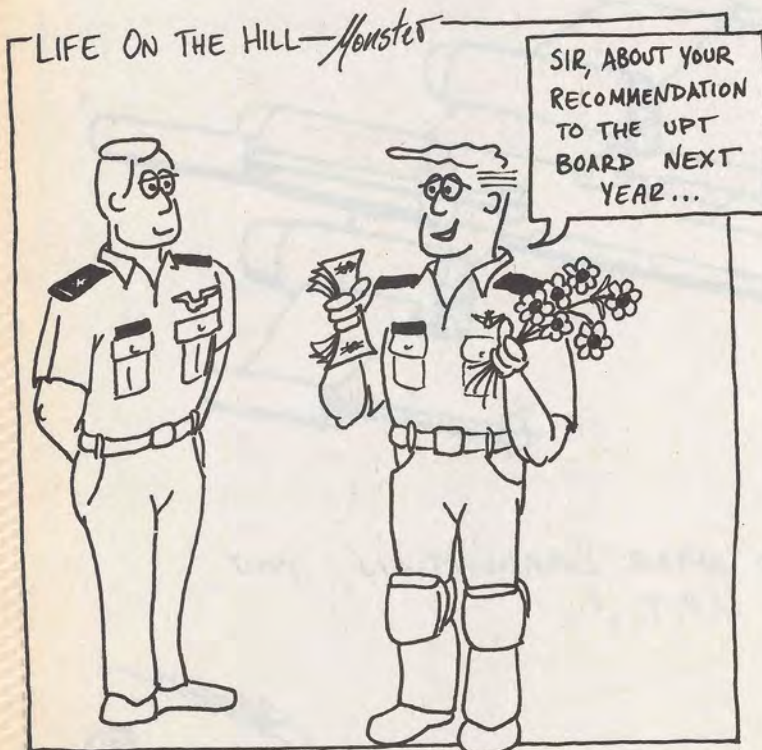

WELL, MY REAL DATE
HAS FINALS AND A PHOTO SHOOT FOR
HER MODEL AGENCY THIS WEEKEND...

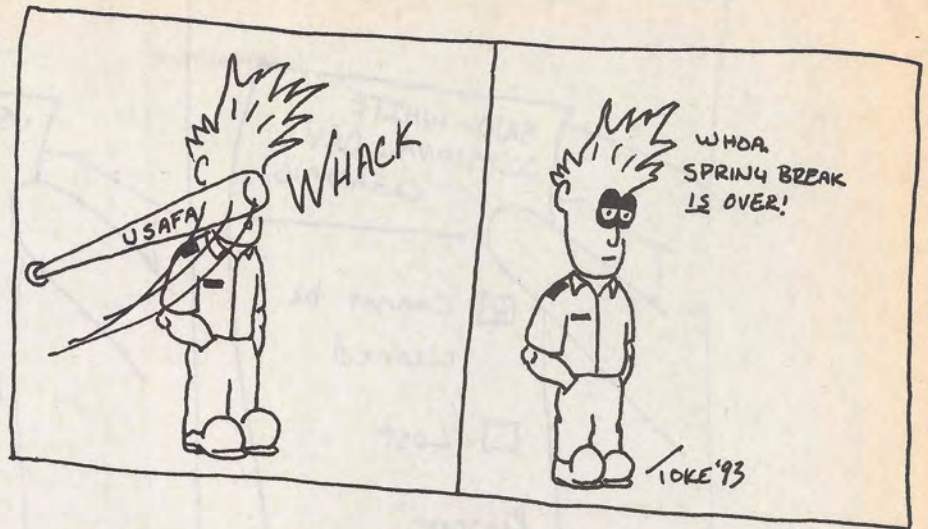

Twas the Night Before CE

Twas the night ere an M-Day,
And all through the wing
Many kaydets were stirring,
Trying to fix one last thing.

There were plots and printouts,
calculations galore.
Air base designs were all over the floor.
Eighty hours of work lay there at our feet,
Sleep was far off even though we were beat.

My room mate was nestled all snug in her bed,
While pavement designs ran not through her head.
She could only imagine the stress and the pain,
Of next semester's CE projects to drive her
insane.

The time that they took, the hours they consumed.
That we'd be up all night was a given: assumed.
The CE department puts 310 at the top,
And seems to forget the other classes we've got.

That week was a light one, four quizzes, one test.
Plus two papers, a project, I was trying my best.
Then to top it all off was CE 310,
And that was all due before Tuesday began!

It's not that designing an air base is tough,
But with so little time it becomes somewhat rough.
Trying to get groups together, find a time when
we're free,
Is usually past Taps, and sometime before three.

But now I can lay me down to sleep,
And pray that a passing grade I do keep.
In case I doze off before this is through,
Be sure to wake me before the next project's due.

MO BARRETT (2)

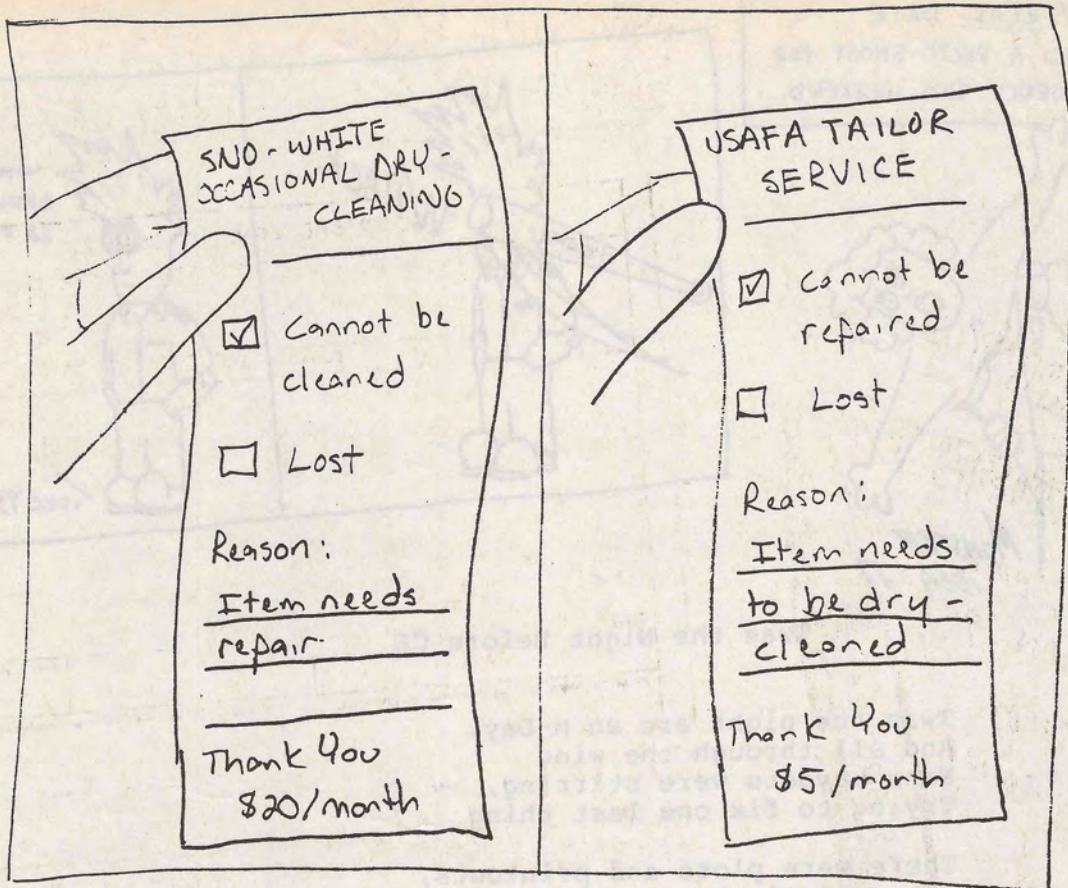

BS

SO THEN YOU TAKE THE DERIVATIVE AND... WHO IS SNORING



Falcon Hoops Huddle

Remember, no less than 20 passes. When the shot clock gets to 2, let Oke or some other freshman shoot.

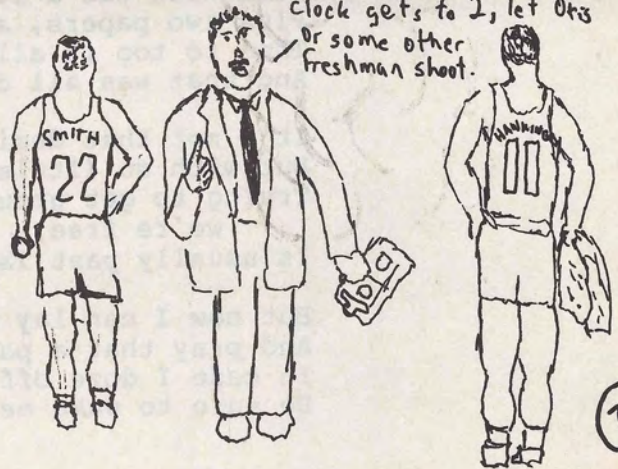

23

COUSIN DAVE

★ IT'S NEW! ★

UNHAPPY?
DISSATISFIED?

JOIN SPIRIT
MISSION '94!
WE'RE READY
TO GET EVEN!



GOOD/BAD CONDUCT REPORT			
CADET NAME (Last, First, MI)		SQ	CLASS
SUMMARY OF CONDUCT			
TIME	DATE	PLACE	DUTY PHONE
PRINTED NAME OF REPORTING INDIVIDUAL		SIGNATURE OF REPORTING INDIVIDUAL	

AFCW Form 10p, JUN 92

THE NEW, CW-APPROVED FORM 10p!!
IT'S FOR PUBLIC USE!!

IDEAL FOR: EX-GIRLFRIENDS + BOYFRIENDS
COLORADO STATE POLICE
DE-JA VU BOUNCERS
WENDY'S PROPRIETORS

GET YOURS TODAY!!



IDEA: MARTY GAUPP

A DoD study concluded that
in five years, the USAF will have
a shortage of pilots....

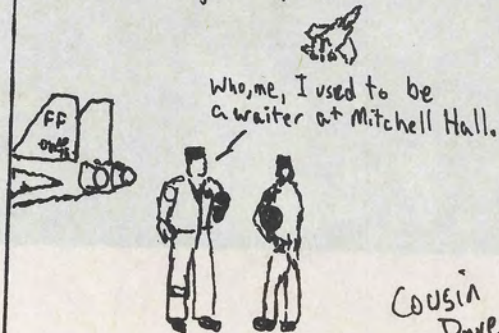

COUSIN
Dave

NEW!

FROM THE MAKERS
OF DEAN VASELINE
AND SCREWTRON....

THE BOOT

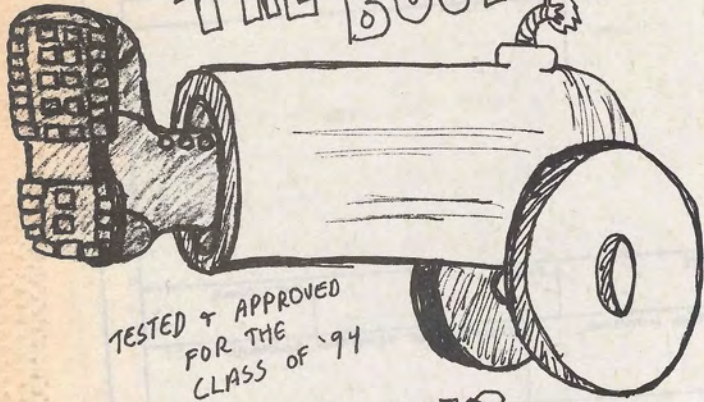

TESTED & APPROVED
FOR THE
CLASS OF '94

KS



YEAH. YEAH.
THAT'S RIGHT;
RING DANCE MADE
PLAYBOY'S TOP 40
SOCIAL EVENTS, YES.
AND I DESIGNED
ONE OF OUR RING
CRESTS! YEAH, MAY
SECOND.....

NOT TOO LONG AGO

IN FIGHTIN' FOURTH....

-SLOW THANKS: DAVE EVANS

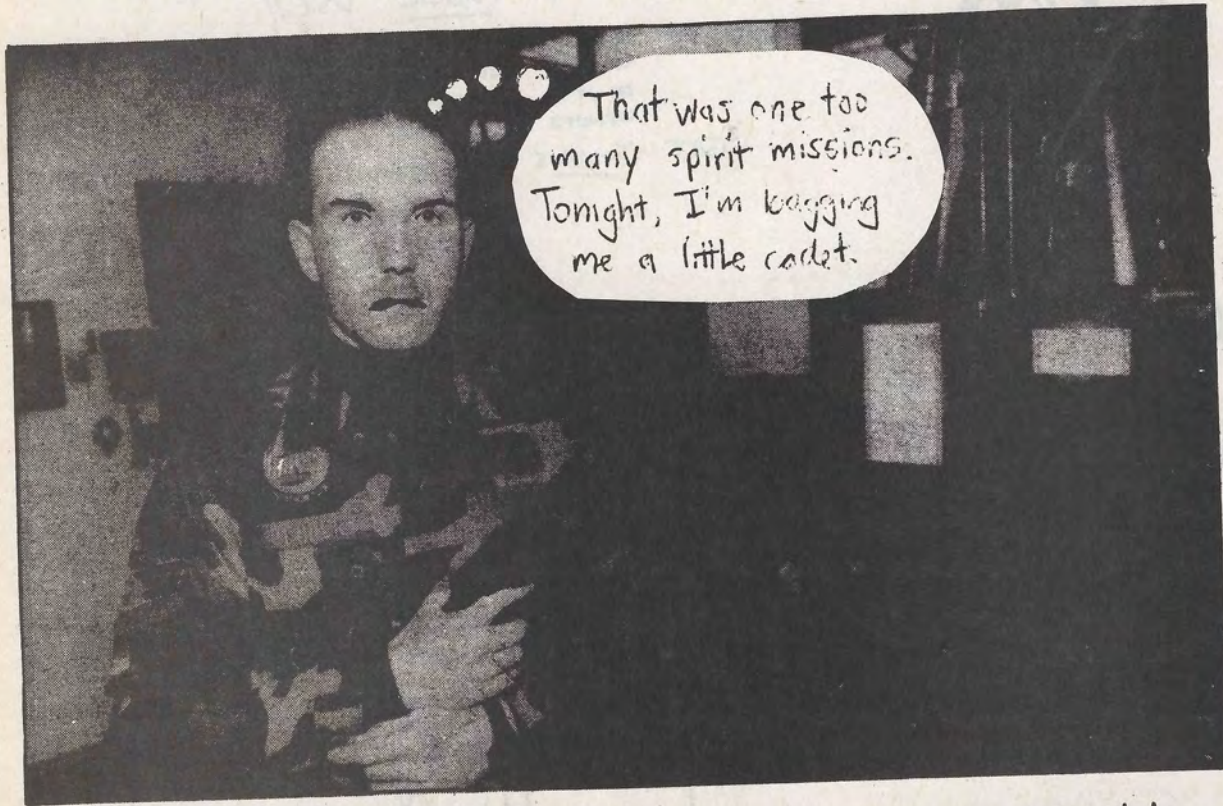

That was one too
many spirit missions.
Tonight, I'm bagging
me a little cadet.

(24)

[Handwritten signature]

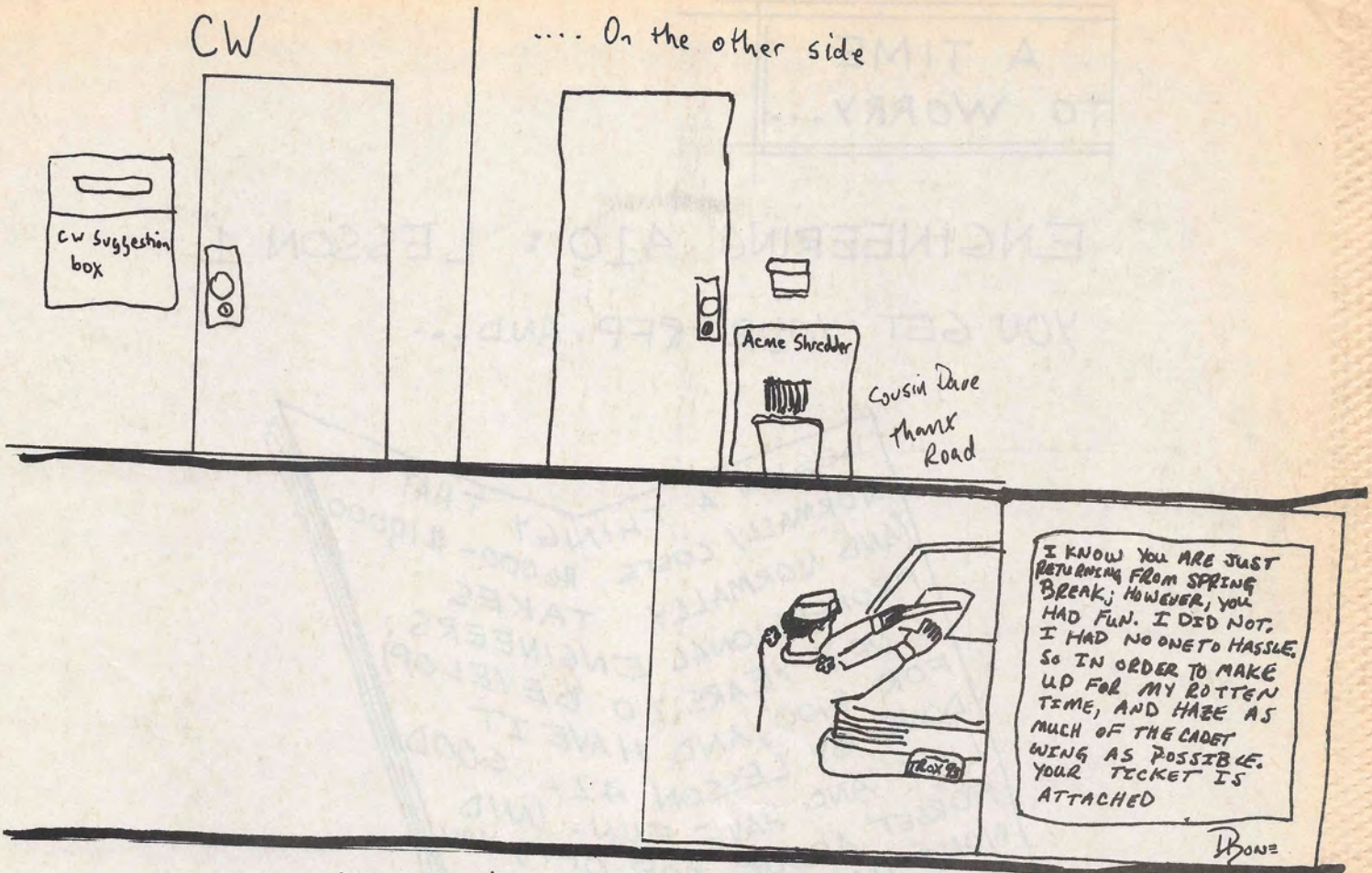

THE VICIOUS CYCLE OF LOVE

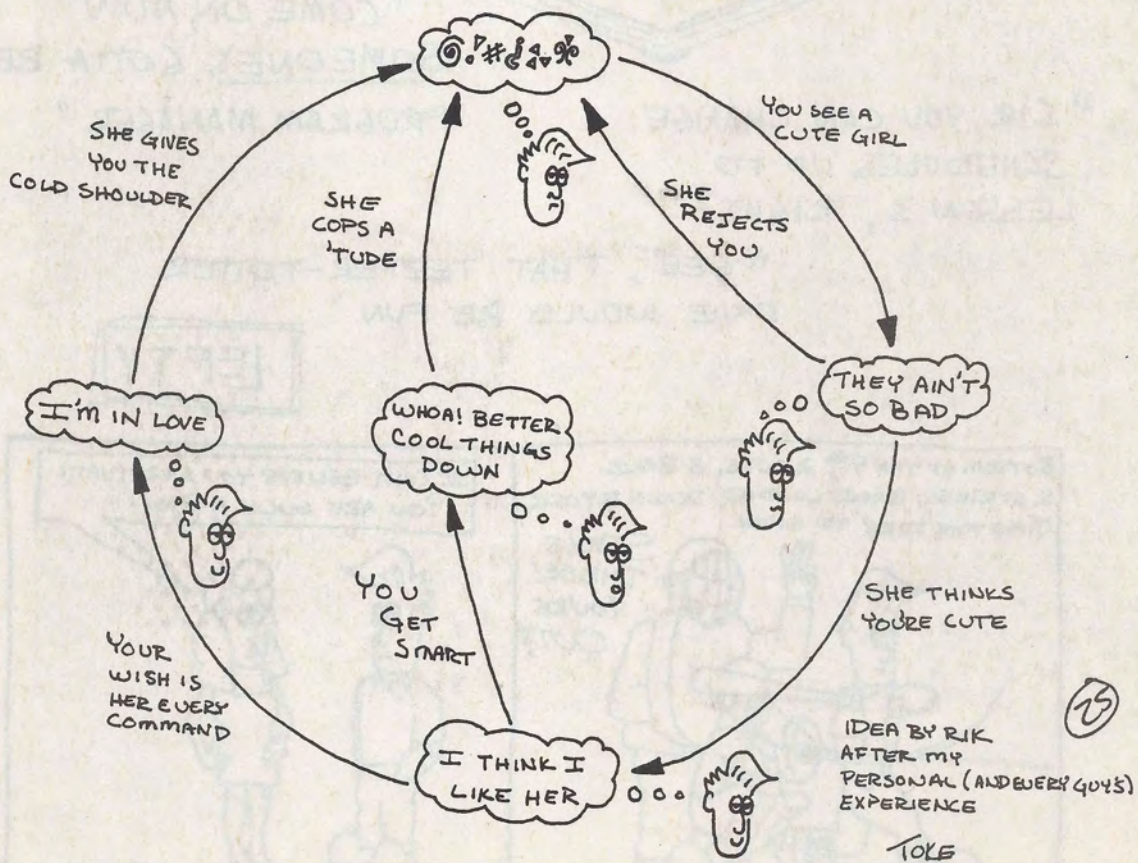

A TIME
TO WORRY...

ENGINEERING 410 : LESSON 1

YOU GET YOUR RFP AND...

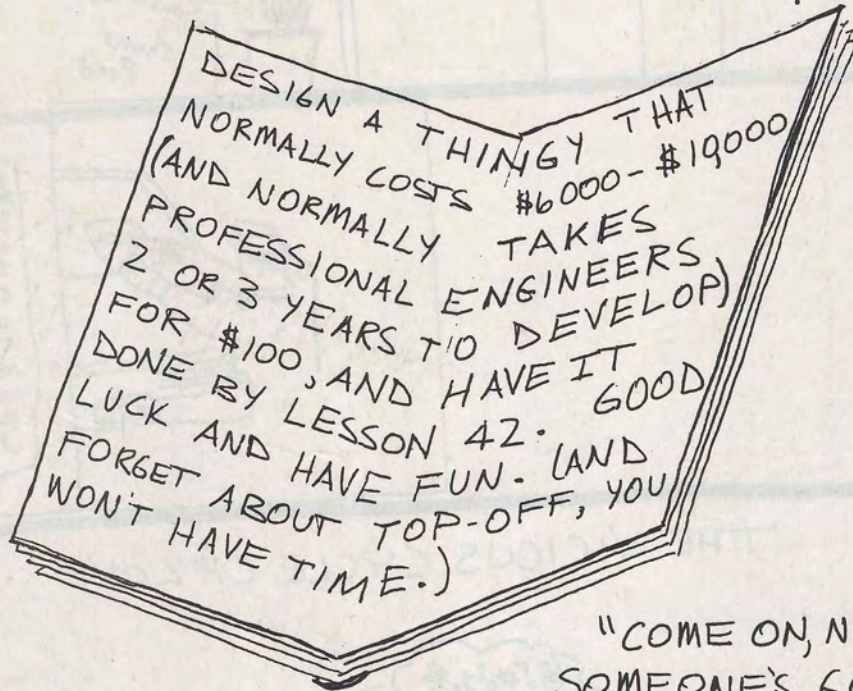

"COME ON, NOW
SOMEONE'S, GOTTA BE
PROGRAM MANAGER "

"SIR, YOU CAN CHANGE
SCHEDULES UP TO
LESSON 3, RIGHT? "

"GEE, THAT TEETER-TOTTER
ONE WOULD BE FUN "

LEFTY



LET'S HAVE FORMATION

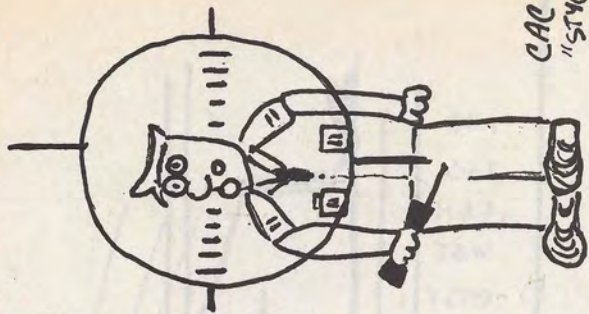

CAC
"STYG"

EYES... RIGHT



Toke

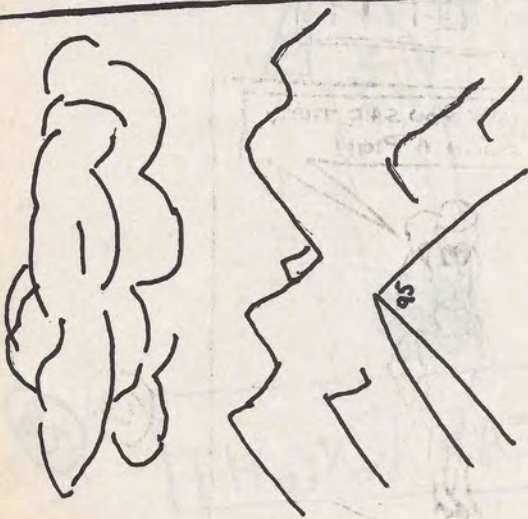
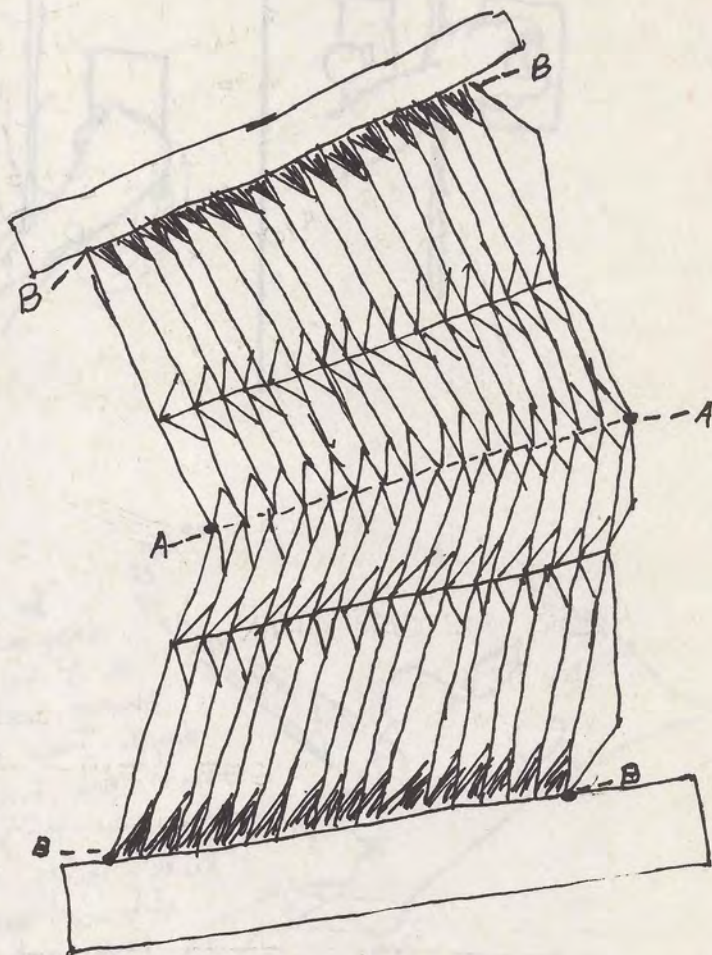
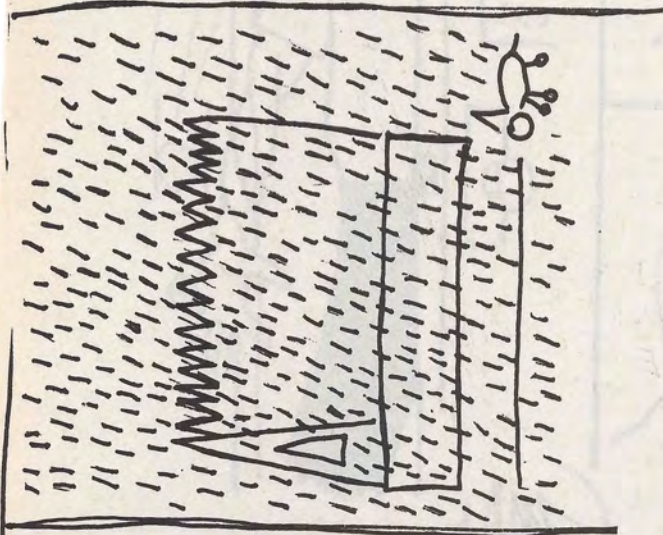

ACADEMY ASSEMBLY - Instructions:

1. Cut out (be careful - scissors are sharp!)
2. Fold at points (A)
3. Fold at points (B)
4. Give keynote address.

(It takes them a week to figure this out?)

- Jim Engle

(27)

THE LIBRARY IS OPEN, BUT THIS DOOR MUST REMAIN CLOSED. TWIST KNOB COMPLETELY AND PULL HARD



THIS IS THE MAIN WITNESS HARD

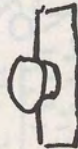

CMAH

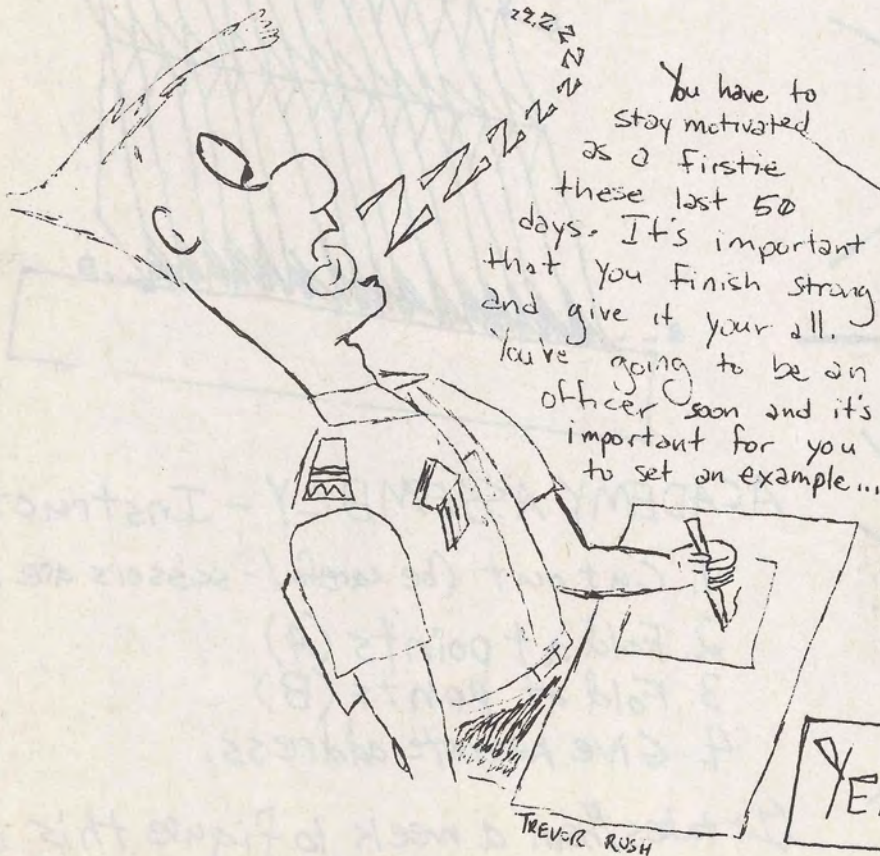

You have to stay motivated as a Firstie these last 50 days. It's important that you finish strong and give it your all. You're going to be an officer soon and it's important for you to set an example...



YEAH RIGHT

TREVOR RUSH

4° at the Beach



Cousin Dave

this really happened to me:



LMH

29

-IF EVEN NCOs KNOW HOW 4° SHOULD BE TREATED, HOW COME CW DOESN'T?

-SLOW

29 JUNE 1988

BRING ME

WELCOME TO
USAF, MAGGOTS!

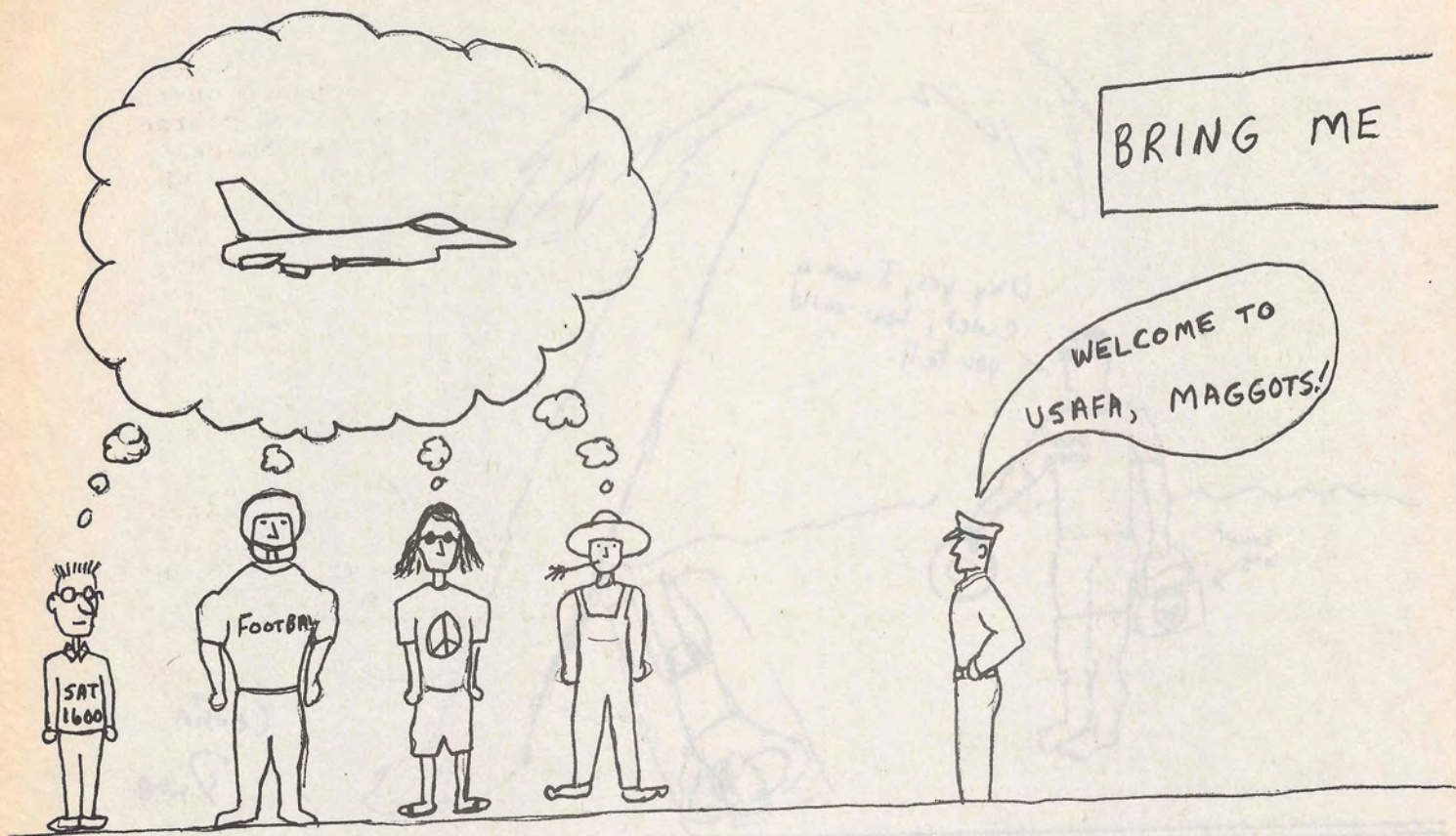

27 MAY 1992

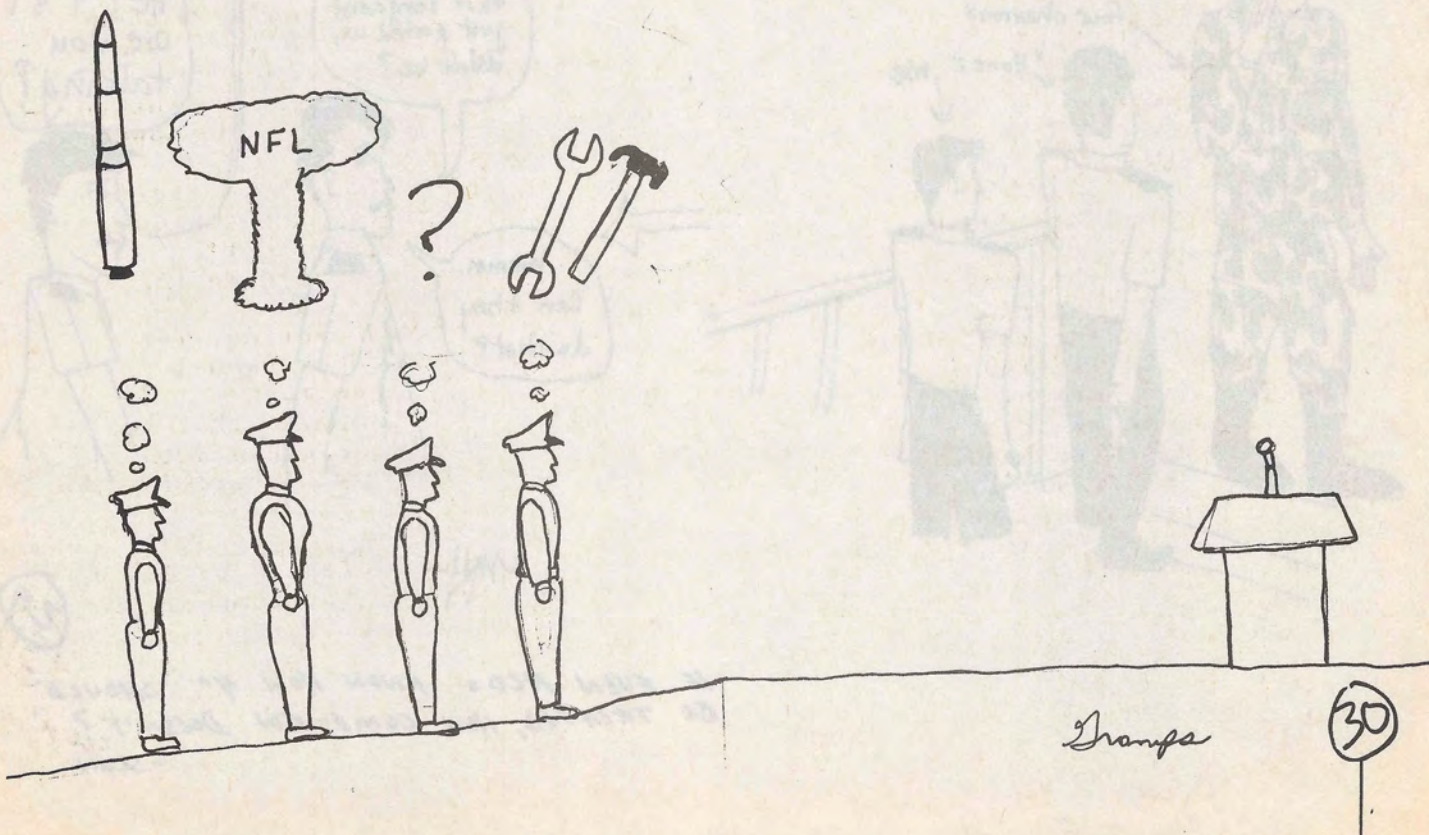

DODO TAILS

It looked like a really good deal. Eighteen free CDs when I bought one for half price. I especially liked the little square on the envelope that read: "Postage will be paid by addressee". I, of course, did not have a CD player at the time, but I was one of those Smacks who assured himself that he would get one right after Graduation, when our pay went up.

But anyhow, I joined this club some two years ago, with magical dreams of a complete Classic Rock CD library. I picked out my free discs, laughed at my idiot roommates (*groan*), and dropped my Post-Paid Business Reply Envelope in the mail.

It was only twelve minutes later when I got my first shipment; and I was thrilled to get these wonderful albums that I needed. Unfortunately, BMG wanted about \$47 for shipping and handling. I was taken aback, initially, but then I realized what a great deal I was getting, and gladly paid the fee.

One month later, as timed by an atomic clock in Indianapolis, I got a letter and catalog from the club asking if I wanted more stuff. Well, I had already taken them to the cleaners once, so I felt too guilty to do it again, and promptly chucked the flyer in my Air Force Waste Receptacle. A half-hour later, that month's Featured Selection was in my P.O. Box. I think it was *Milli Vanilli's Greatest Hits*. I quickly sent back this errant package, assured that they would reimburse my postage price. Hah. What they did was credit my account for future purchases. Of which I had to make 2,300 in the next two years.

So I became a Member of the Club. I dutifully ordered the expensive albums (which I didn't particularly like, but the cheap ones don't count to my obligation). I sent back the monthly flyers for CDs like "Mickey Mouse Goes to Hell", slapping a stamp over the little square that reads: "Put Stamp here. The Post Office will not deliver mail without proper postage".

I finished my commitment. As a reward, I got to order two free CDs. Did I learn my lesson? Of course not, I'm a History major. So I get these two discs, and they want \$3.86 for shipping and handling. I send the box back with the stipulation that they can return them to me only if I don't owe postage. So they send them to me again. And ask for \$3.86. (You still with me? I've already spent 29 cents for 24 months sending back their mailer, and the five bucks it took to return the "free discs"). I sent a letter explaining how, in fact, they owed me money, but I would let them go this time.

That held them for about nine days. Then I got a signed letter from Joseph E. Macrino, Manager, Fulfillment Services (which sounds like a good department, but really isn't). He gave me explicit instructions on how to send him a check for my bill and told me to "...do it right now, before it slips your mind."

Well. I wasn't going to take any crap from mister Macrino, let me tell you. I ignored him and got a signed letter from James Pendel, Manager, Collection Accounts, who threatened "...to take more aggressive action." Ooooooh. I was in trouble now. He implied that he would slash my credit rating for the \$3.86 I hadn't come clean with. So I decided to handle it they way I had learned from my mother: I called up Mr. Macrino.

Here's where it gets weird...

Neither Macrino nor Pendel exist. They are names created by BMG and registered with the Trade Commission as patsies for the company. So talking to them was out of the question. I did like their signatures, though. But I'm not going to pay my bill.

I mean, hey, is some fictional Muppet going to kick my ~~ass~~?

31

-SLOW

TOP TEN RUMORS ON HOW THE COMM
HURT HIS KNEE....

- 10 Major Clark tackled him in
the parking lot
- 09 Riding the F-16
- 08 Kicking DF for leaking
the date of Recognition
- 07 He missed the light pole
- 06 Teaching waiters to
drive buses
- 05 Kick-starting his Harley
- 04 He fell of the ball washer
on the ninth green
- 03 Naked fire-jumping
- 02 A bizarre gardening accident
- 01 Skating on the Terrazzo

-The Gooch

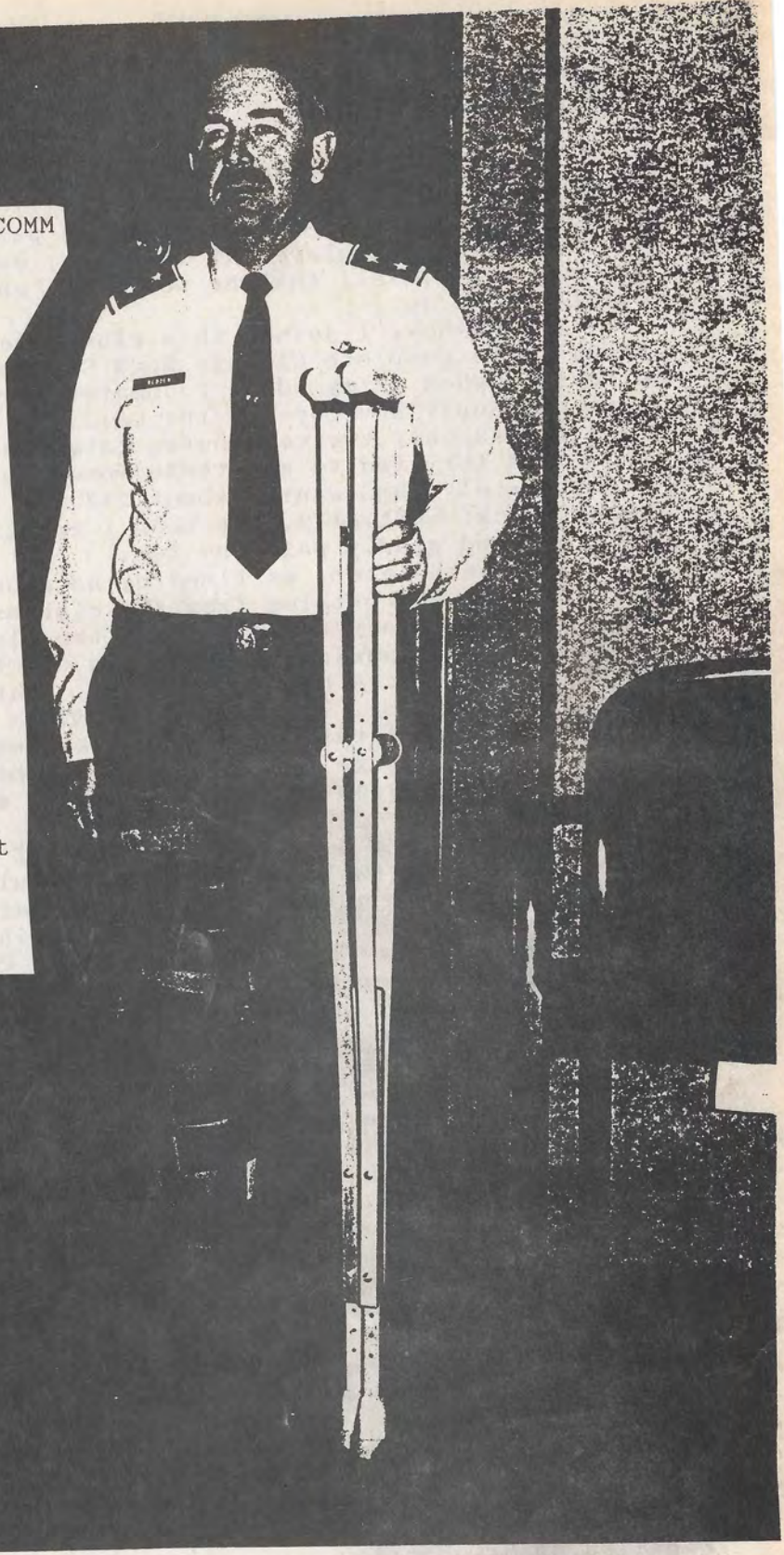

THANKS TO: WHOEVER IT WAS WHO SENT US THE PHOTO!

32