

DODO



Dodo (dō'dō), n. pl. -dos, -does. 1. Any of several clumsy, flightless, extinct birds of the genera *Raphus* and *Pezophaps*, related to the pigeon but about the size of a turkey, formerly inhabiting the islands of Mauritius and Réunion. 2. Slang, a dulwitted, slow-reacting person. (< Fr *doude* < *doude* silly) — *dō'do-lom*, n.

Volume 31 Number 5

May 1987

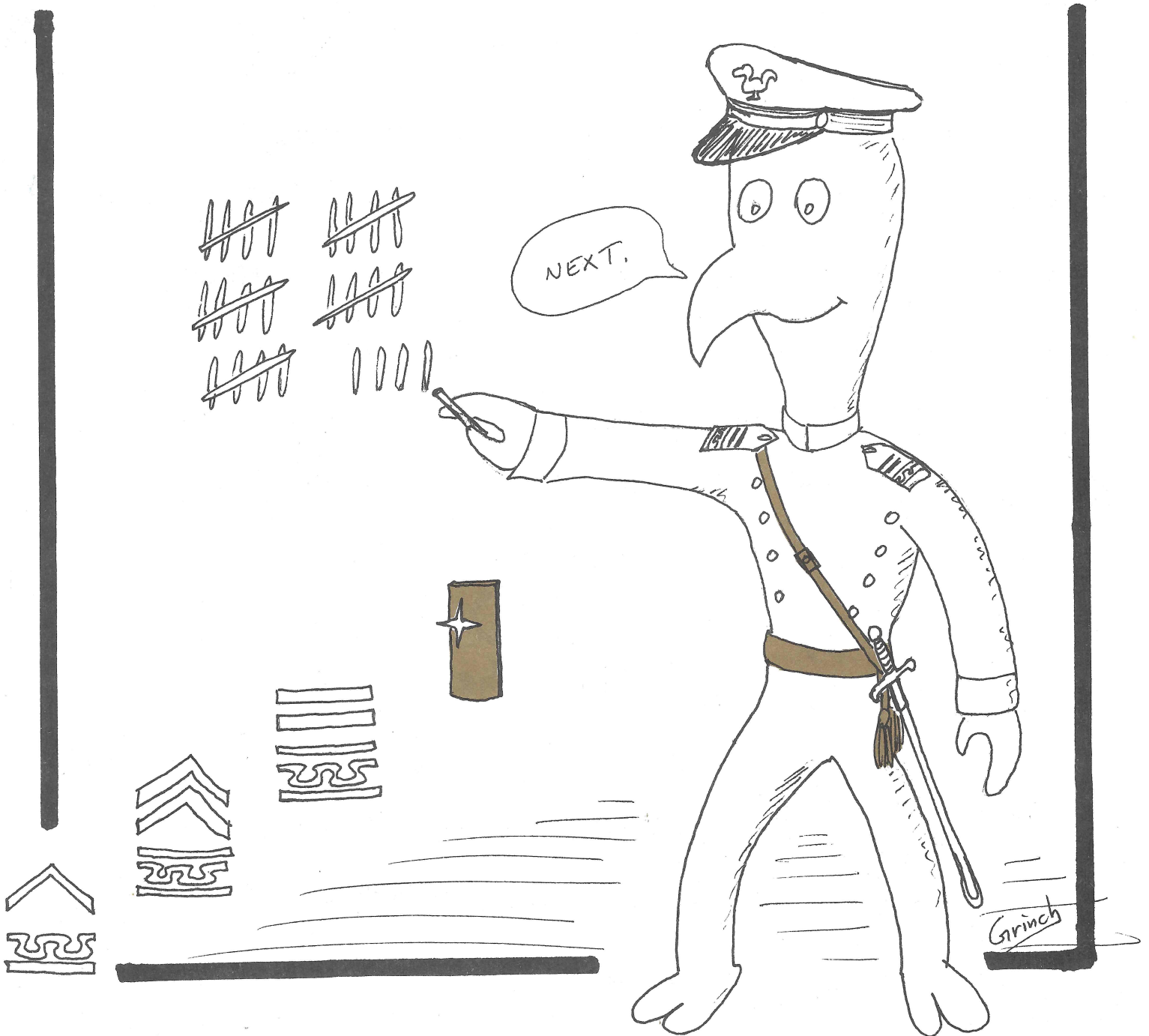

Welcome to the last issue of Dodo this year. We all hope you've enjoyed reading it as much as we have putting it together. If you haven't, you can [redacted], [redacted], and [redacted]. Then you can walk around with a big smile on your face all day.

Seriously, It has been quite an honor for me to put this together this year. Thanks to everyone for their comments and material.

For those of you who remember George Birsic .. the editor last year .. he says "hi" from sunny California. (Everyone say 'hi George'). Its not his fault if he was in the class of '86.

Oh well, time to move on. Paul Daly ('88) will be the editor next year. Until then, read, enjoy, and Good Luck '87.

Dodo, for cadets, by cadets.

- Dave

We never got around to staff pictures this year, so we all got together for this quick sketch.

CIC Rich
Scott
(censor magnet)



CIC Dave
Butler
(Editor)



CIC Paul
Daly
(NEXT EDITOR)



CIC Kevin
Smagh
(advertisements)



CIC Phil
Templin (Raps,
etc.)



CIC Dean
Pfeub
(right field)



CIC Tsuyoshi
Tung (Resident Trainer)



CIC Ralph
Galetti
(sick humorist)



CIC John
Bystroff
(writer / cynic)

CIC Mike
Russell
(covert Talon)



CIC Jeff
Hunt
(cartoonist)

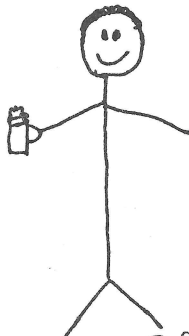

Of course, the frosted mugs only have ROOT BEER in them -- we were in a cadet room at the time. Not that we would ever imbibe irresponsibly. Nor do we take cereal boxes from other people's tables at breakfast, or blow-off PMT lessons

Thanks also to Chris Jeffries and Mark Clanton

Oh, yes, and let us not forget the ██████████ Censors.

(Thankyou)

-Ed.



We here at DODO would like to take this opportunity to thank all of our readers out there--without whom, our success as of late would be extremely limited. Your continued support has lead to, I think--and others tell me-- one of the best years DODO has ever had. However, I would like to recognize some very special readers who, I just recently found out, subscribe to DODO and get their very own copy sent to them in distro every issue.

SUPT--the Superintendent, of course. Thanks, sir!
XPD --someone under the Chief of Special Staff, as far as we can tell
CW --the Commandant of Cadets
CS --Chief of Staff
CWV --Vice Commandant
CWD --Deputy Commandant
CWI --Deputy Commandant for Military Instruction
CWO --Deputy Commandant for Operations
CWQ --Cadet Wing Squadron Orderly Room (where's that???)
AOG --Association of Graduates
CSV --someone under the Chief of Staff
DA --Director of Administration
HC --Command Chaplain
DE --Civil Engineering(what do they use it for?)
SP --Director Security Police
SG --Commander/Surgeon (as long as they don't read it while they operate)
AC --DCS/Comptroller
BS --(?!)
SGP --the clinic
RR --Registrar (humor-r-r)
DAR --the printer (as in--"over dar")
XP --Chief of Special Staff
HO --Command Historian
IG --Inspector General
LG --DCS/Logistics
DP --DCS/Personnel
AH --Director of Athletics
AHB --Business Office
PO --sorry, couldn't find this one
HCD --Chaplain's office
AHI --Sports Information
ACE --Accounting and Finance
CWIS--Military Studies
CWH --Director of Honor and Ethics
PA --Public Affairs
OSI --THEM!!!!
CWX --Plans, Policy, and Scheduling
LGC --Director of Contracting (now they've gotten alot of business from us lately)
SSS --MWR Supply
LGCSB--Small Pur Br Appropriated (whatever the heck that is)
CWINT--sorry, wasn't in the phone book(but I'm sure I'll hear about it)
557SPS--someone at the 557th, obviously.
1876CS--Communication Squadron
CWD-1,2,3,4--you know who they are
DFSELF--Someone in the Library

A sincere thankyou to all our "closet DODO's"for their continued support, and our apologies in advance if we missed anyone.

- The Editor

MY CORONA

by Philip Templin

(sung to the tune of the Knack's "My Sharona")

Ooh, I feel the weekend's near;
I need a beer.
All I want to do is have MY CORONA.

Just waitin' for that precious time
To squeeze the lime,
And stick it in the bottle of MY CORONA.

Never gonna stop-
Every drop-
I need to clear my mind.
I always buy the top
When I shop;
I'll drink no other kind.

My-my-my-ay-uh wooh!
M-M-M-MY CORONA!

You know it really gets to me,
The ecstasy,
To put my thirsty lips around MY CORONA.

That lovely yellow chemical
Is never dull.
I couldn't miss a dosage of MY CORONA!

Never gonna sink;
It's my link
From the daily race.
I only need a drink
Just to think,
And to save my face.

My-my-my-ay-uh wooh!
M-M-M-MY CORONA!
M-M-M-MY CORONA!

(Instrumental)

I've never seen such good beer flow
From Mexico.
My throat is never dry when I have MY CORONA!

It's my way to be elite,
And beat the heat.
I'll always look ahead to having MY CORONA.

(continued)

MY CORONA
(continued)

Never liked it here,
Dreamed of beer
During Friday's class.
I always thought it queer
How such cheer
Could fit in a glass.

My-my-my-ay-uh wooh!
M-m-m-m-m-m-my-my-my-ay-uh wooh!

M-M-M-MY CORONA!
M-M-M-MY CORONA!
M-M-M-MY CORONA!
M-M-M-MY CORONA!

(Instrumental)

Oooooooooaaaah MY CORONA!
Oooooooooaaaah MY CORONA!
Oooooooooaaaah MY CORONA!

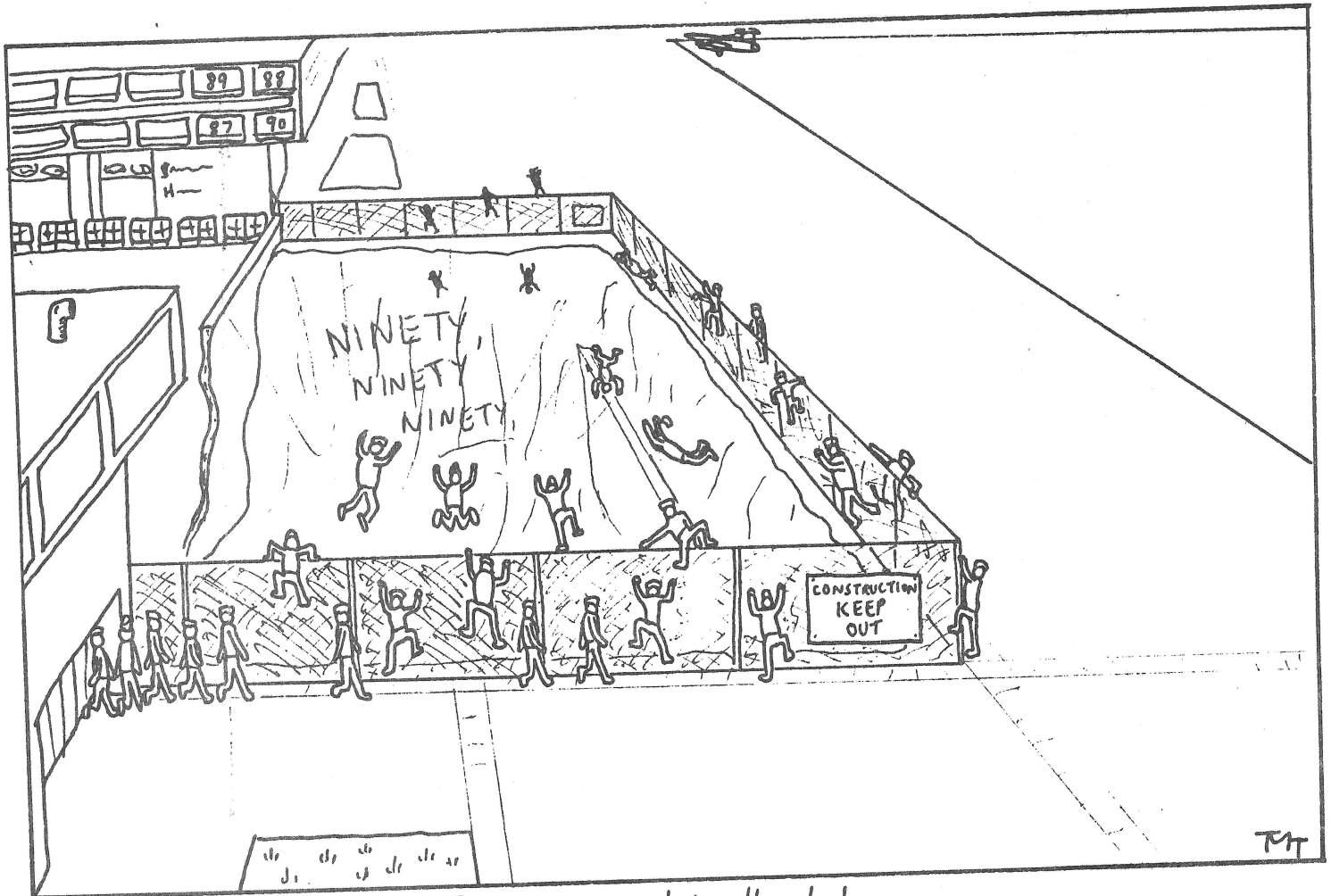

Fourthclassmen take the hole

Just when you thought you had heard the last of '86, some CAP cadets decide to get in on the action... and they didn't even know them! I guess the letter speaks for itself.
 -Ed.

"DEAR DAVE:"

Some of us "wannabees" on the outside caught the Holiday DODO and found it mildly amusing. The TLC contest results especially intrigued us, and we felt compelled to send you a few of our own:

- Terribly Large "cheeks"
- Those Lecherous Comrades
- Temporarily Living Corpses
- Tactless Little Cretins
- The Little Cowards
- Those Lawbreaking Cadets
- Terrazzo-Licking Crowd
- Their Leadership Crumbled
- The Loser's Club
- Terribly Low Caliber
- They Lacked Chastity
- They Like Corsairs
- They Looked Conceited
- and on and on and on.

our favorite →

In case our USAFA friend doesn't, please send us a copy of the next DODO -- little things like that make life out here more bearable for those of us that wish we were in there.

Some CAP cadets
 Somewhere in Utah...

ATTN: DAVID BUTLER
 USAFA ACADEMY, CA 95834
 ST WING MEDIA OFFICE
 (DODO)
 7

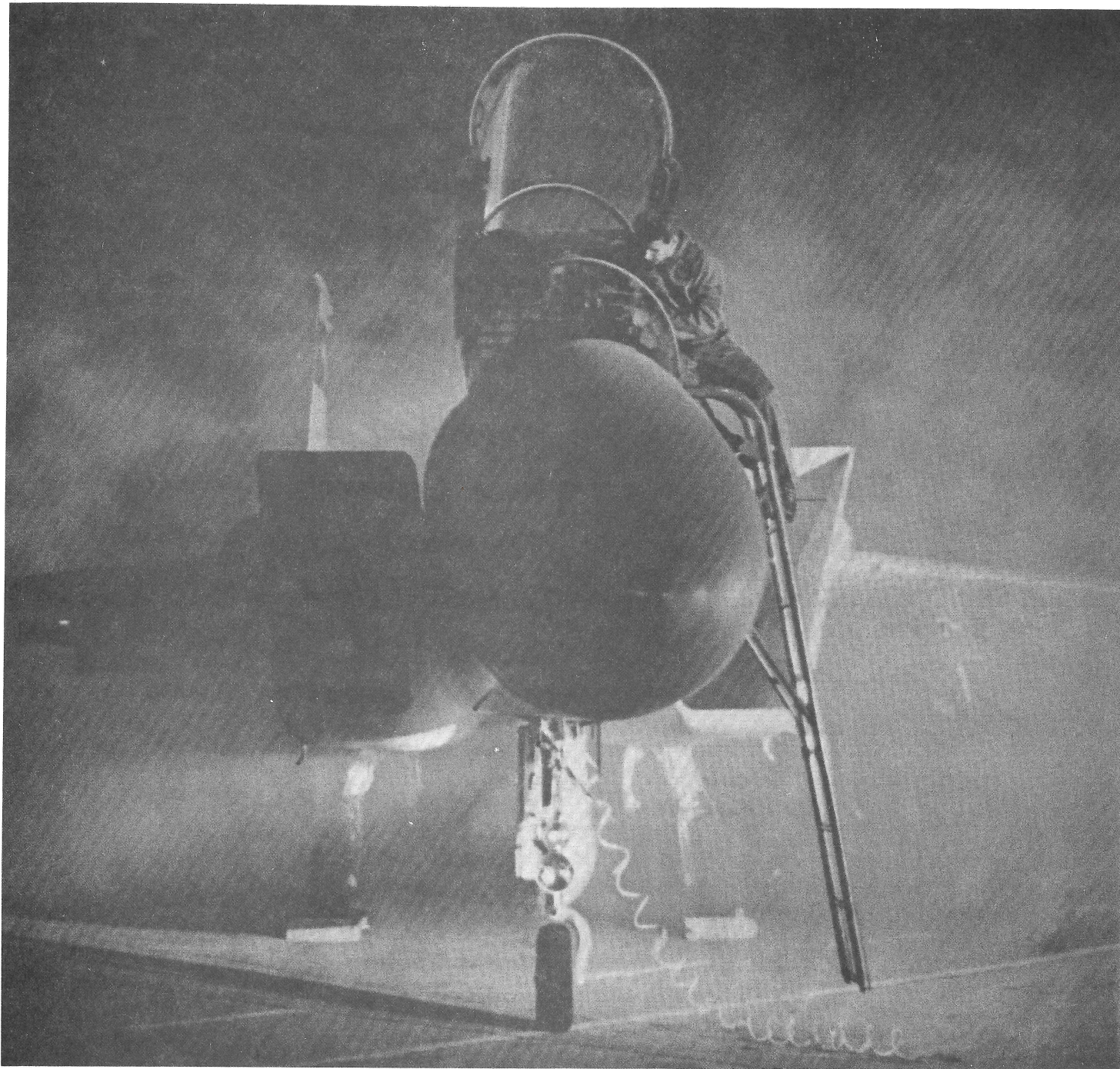

We'll pay you to take the most exciting classes anywhere.

For Lang 131-132. 1-1/2 (2-1) Econ 221. Principles of Microeconomics. 1(1)*
 Math 211. Differential Equations with Matrix Algebra. 1(1) PMS 111. U.S. Airpower and Force Applicat
 History 101. Modern World History. El Engr 310. Signals and Systems. 1
 Mil Tng 332. Summer Scientific Seminar. PMS 221. Airpower Theory and Doctrine. 0(1)*
 Inst Tch 102. Basic Typing Mgt 203 Examines Reading skills to
 Pol Sci 200. Introduction to Political Science. Aero 311. Fundamentals of Aeronautics. 1/2(1x)*
 Mil Tng 412. Falcon Mascot 0(0) English 330. Technical Composition and Speech
 Econ 222. Principles of Macroeconomics. 1/2(1x)*
 Introduction to macroeconomics, with applications
 national income determination

An intensive course that polishes the skills of chemistry with added
 Chem 111-112. General Chemistry. 1-1(1-2)

Dear Cadet Butler,

As Director of Operations for USAF Special Command, I oversee many projects, including a recent study of various adaptations to the T-41 Mescalero.

In light of current trends in the Air Force toward multi-mission aircraft, I thought that your DODO readers might be interested in seeing some of the designs on the drawing board.

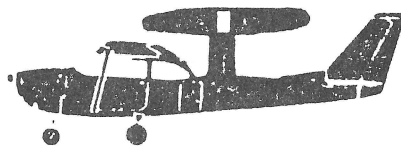

E-41A
AWACKY

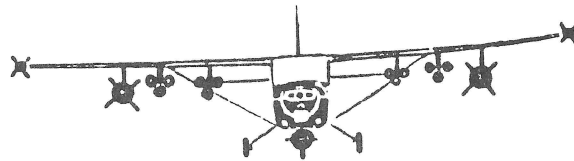

F-41E
Strike Mescalero

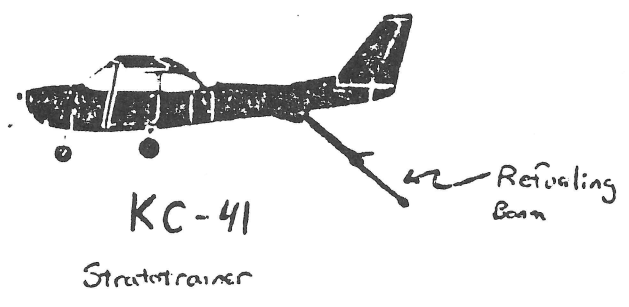
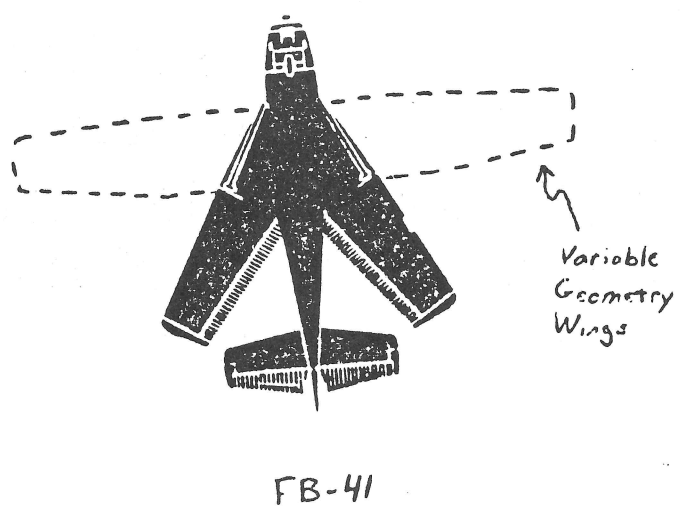
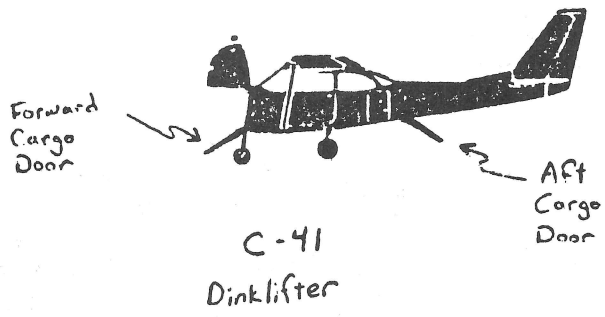

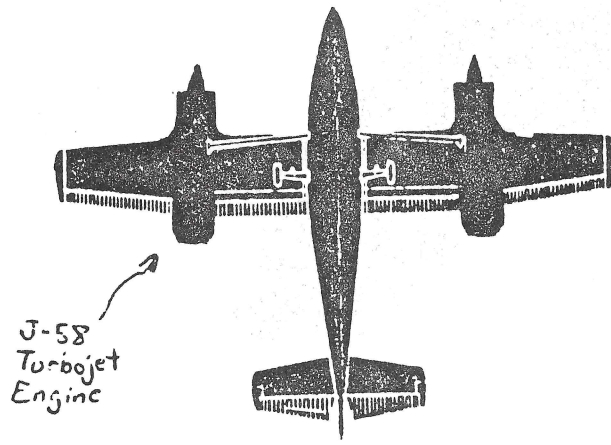

J-58
Turbojet
Engine

SR-41
Redandwhitebird

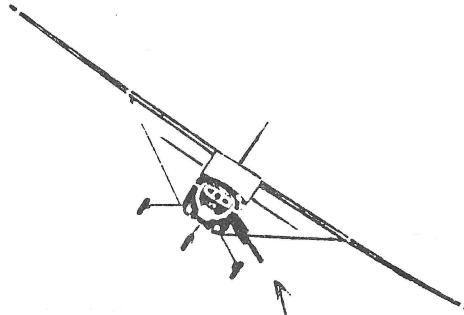

AC-41H
Specterlero

105mm
Howitzer

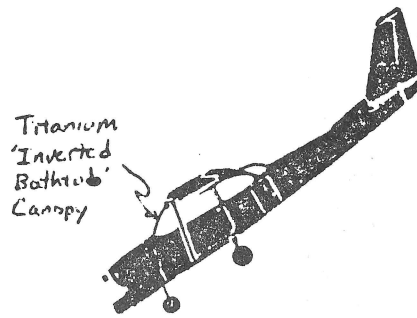

Titanium
'Inverted
Bathub'
Canopy

30mm
Gatling
Gun

A-41
Mescabolt

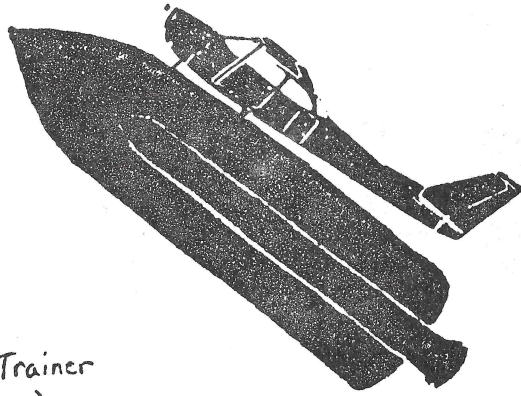

STS
(Space Trainer
System)

WHEN '90 RUNS SERE...

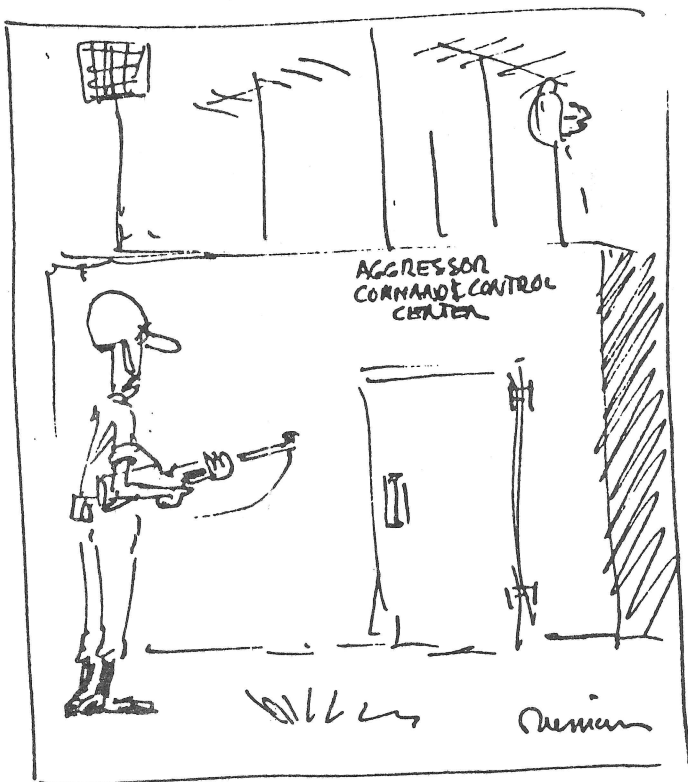

"OK, THROW DOWN YOUR COMPUTERS
AND COME OUT WITH YOUR HANDS UP!

THE USAFA SIDE

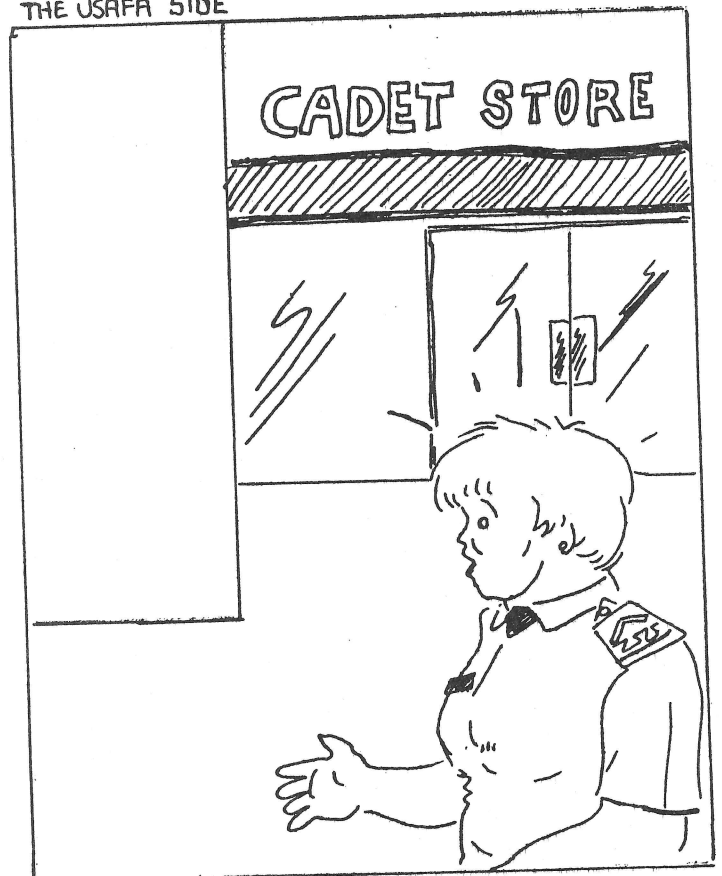

SHE COULDN'T FIGURE OUT JUST HOW SHE
GOT THERE, BUT IT NO LONGER MATTERED.

Hey, are you tired of your T-41 I.P. constantly nagging, complaining, and bickering to you about procedural knowledge? Well, here's a chance for you to get back. Similar to the academic quizzes you T-41 "Top Props" have struggled through, here's a quiz you can give your I.P.

—PHIL T

T-41 IP Quiz

1. You're in Area 5 and your student is doing power-on turning stalls. A sudden, unplanned rolling motion occurs and your student jumps on the wing-low rudder pedal, causing the plane to spin downward at an increasing rate. He then sticks the control lock into the yoke shaft. What do you do?

- a.) Make sure the cabin air and heat knobs are in.
- b.) Check the ball and slip indicator.
- c.) Smoothly apply brakes.
- d.) Cage the heading indicator.
- e.) Make sure he stays within the area boundaries.

correct
answer →

2. It's Saturday morning and your student is accomplishing the "Before Takeoff" checklist. All of a sudden you notice that he had just released an obnoxious beer [redacted]. You should

- a.) See if you can beat his by drowning out the noise of the 1800 rpm engine run up.
- b.) Do the fume elimination procedures.
- c.) None of the above.

correct
answer →

(Trick question: No cool IP would make a student fly on Saturday morning.)

3. Your student comes back from spring break with a hangover and has forgotten everything. You should

- a.) Fanagle the paperwork and get him out of the program.
- b.) Give him a review ride.
- c.) Give him 2 review rides.
- d.) Tell him he needs to shine his boots.

correct
answer →

(importance of military standards)

4. You find yourself on downwind and all of a sudden the laws of the universe collapse, as space-time ripples and time warp fluctuations hurl you 500 years into the future. You should

- a.) Notify tower of your situation and request to be beamed down.
- b.) Establish a 95 mph climb and look for "Lost in Time" procedures in your In Flight Guide.
- c.) Start drinking lots of water so as to thoroughly flush your body of toxic chemicals before the urinalysis.

correct
answer →

5. You and your student find yourselves over-involved with the map trying to locate an eastern area. You look across the instrument panel and notice that the altimeter reads 100,000 miles MSL. You should

- a.) Establish an orbit around the moon and refer to the checklist for lost procedures.
- b.) Attempt to re-enter the Earth's atmosphere, using the wing-low method to compensate for jet streams, prevailing winds, and thermal drift.
- c.) Establish a level flight attitude and maintain Earth orbit until a chase shuttle can be sent up.
- d.) Open the pilot's window for ventilation.

correct
answer →

6. The high G forces experienced during slow flight cause your student to black out. You, yourself, start feeling dizzy. You should

- a.) Establish a 95 mph climb to get into thinner atmosphere.
- b.) Take your student's money while he's unconscious.
- c.) Ignore the student and continue the area work.
- d.) Refer to your In Flight Guide for "Student Restart During Flight" procedures.

correct
answer →

7. After having dozed off while ascending to the Butts Corridor, you wake up and notice a strange phenomenon: the ground is completely covered with clouds; in addition to this, Rockrimmon, I-25, the Embassy Suites, Cheyenne Mountain, and Pikes Peak are hanging upside down from the sky. You should

- a.) Switch to "Eagle" frequency and notify all other aircraft that Colorado Springs is currently upside down.
- b.) Continue your descent into the clouds and wait for Colorado Springs to return to normal.
- c.) Lock your shoulder harness and prepare to brace yourself against objects that may be falling from the city.
- d.) Ignore these trivial distractions and begin to harp on your student for not remembering the "Level-off" checklist.

correct
answer →

FROM SURFER magazine ↓

WORLDLY WISE

I am a California surfer who is spending a year around the world. It's my third month (I'm in Europe now), and I've only surfed three times. I was traveling in Germany, and happened to go to Berlin—which everyone knows is surrounded by a communist country. I went to the Wall, and happened to see an East German border guard in a tower. I yelled to him, "You're bummed; you will never know what surfing is." He heard it, and dismissed it as the usual gibberish they always hear coming from the other side.

Can you imagine people not having the freedom to ever see an ocean—never mind surf in one? So the moral of my point is we have so much, whereas others have nothing at all. So paddle out with a smile on your face and realize how lucky we are, as surfers—and above all—as free people.

Nicholas Copeland,
Pacific Grove, CA

P.S. Hello to the Peninsula crew. I miss you guys. Rip it.

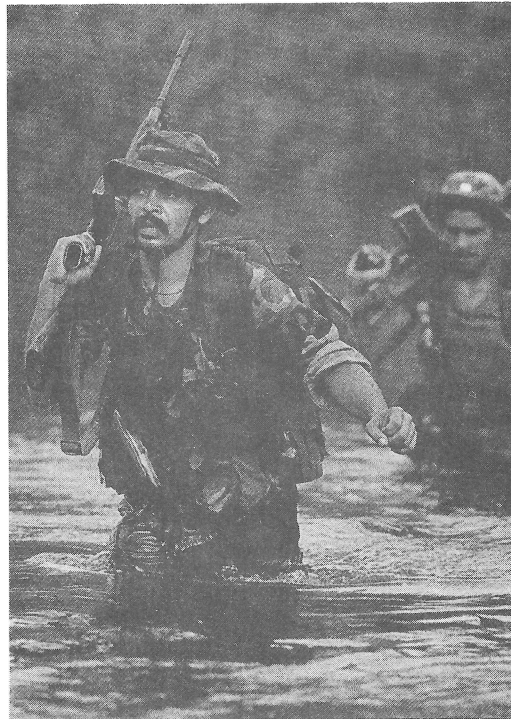

←
the new SERE
Instructors...
life might be
a little bit
rougher this
year.

some justification for cadets ↓

Tuition is on the rise, sparking a fierce new debate among educators

Does college cost too much?

RAISING THE ANTE

Since 1970, private and public institutions have hiked annual tuition greatly. A sampling:

	1970-71	1986-87	% change
Harvard	\$2,600	\$11,390	+338%
Stanford	\$2,400	\$11,208	+367%
Oberlin	\$2,400	\$10,700	+345%
Tulane	\$2,108	\$10,080	+378%
Vanderbilt	\$2,000	\$9,300	+365%
University of Michigan			
In state	\$568	\$2,610	+360%
Out of state	\$1,800	\$8,344	+364%
University of Texas at Austin			
In state	\$100	\$480	+380%
Out of state	\$400	\$3,600	+800%
University of Nebraska at Lincoln			
In state	\$355	\$1,313	+270%
Out of state	\$855	\$3,570	+318%

Note: University of Michigan 1986-87 tuition is average for undergraduates. University of Nebraska 1986-87 tuition is based on 30 credit hours.

LEADING THE PACK

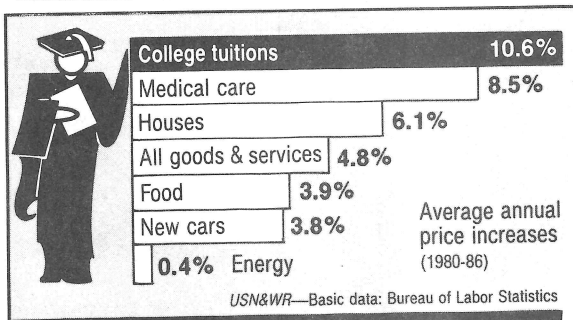

“My grade point average jumped from a 2.6 to a 3.4 since Army ROTC showed me how to make the most of my time.”

(and switch from →
EE to fine arts)

Robert Bright, Junior
University of Idaho



CHAOS in the east quad of Sijan Hall: are we being too lenient?

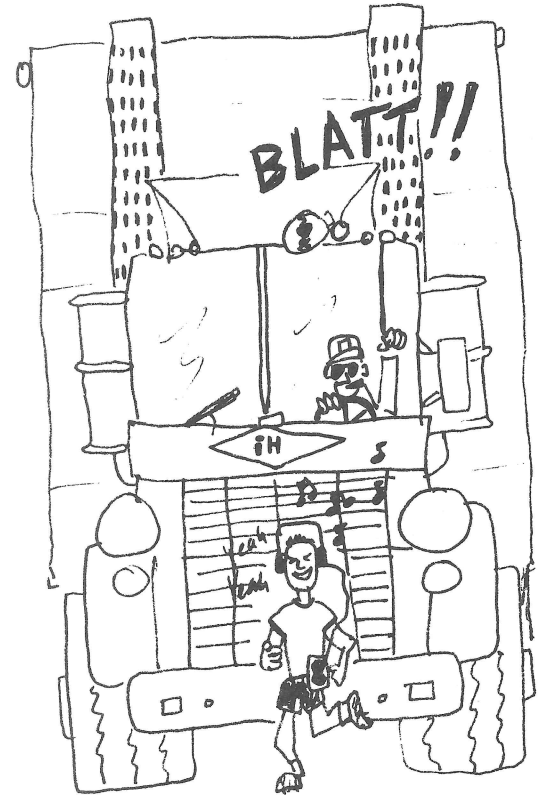

DILEMMA: Your date for the ring dance just dumped you. A or B? You need a date quick. Pick one or the other.

A

B



“My other college courses just talk about leadership and management. In Army ROTC, we’re doing it.”

where USAFA does their shopping

CONTEMPORARY BEDS MAKE SMALL BEDROOMS LARGER!

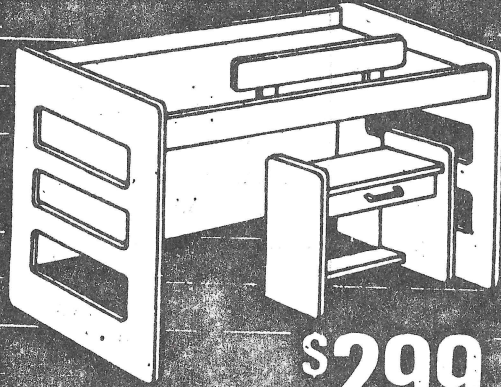

Now **\$299**

PLAYSPACE LOFT BED. A clean simple design with 2 built-in ladders. Red, white, blue, yellow or almond. Will accommodate study center below sleeping surface. Reg. \$400

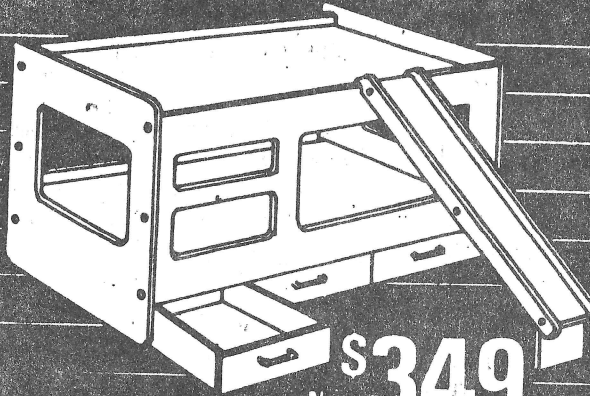

Now **\$349**

THE ULTIMATE CHILDPROOF BUNK BED. Built-in ladder. Choice of red, white, blue, yellow or almond. Under drawers and slide are extra available options. Reg. \$500

UPDATE on the old furniture from Sijan Hall: they want to Fort Corson for a modernization project.



Product Warranty

UNICOR, Federal Prison Industries, Inc., warrants this product to be free from defective materials and workmanship.

If the materials and workmanship in this product do not meet contract specifications, notify our Quality Assurance Department immediately. (Refer to specific product areas in the UNICOR catalog for additional warranty information.)

We stand behind our products and your satisfaction is our ultimate goal.

Customer inquiries should be directed to:
H. E. ROGERS, JR.
Corporate Quality Assurance Manager
UNICOR, Federal Prison Industries, Inc.
320 First Street, N.W.
Washington, D.C. 20534

Telephone: (202) 272-6314 or FTS 272-6314
AUTOVON 285-1204

Warranty

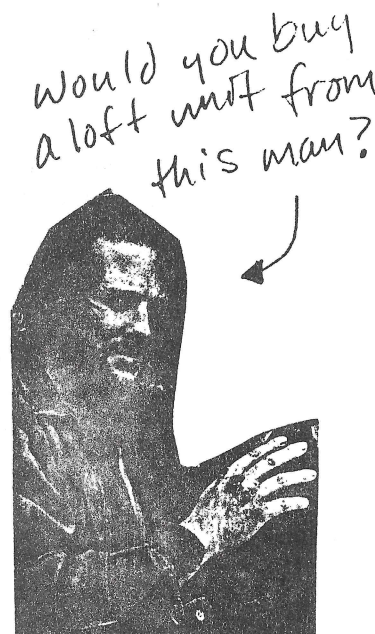

Would you buy a loft unit from this man?

Tear Off at Perforation



DEPARTMENT OF THE AIR FORCE

HEADQUARTERS UNITED STATES AIR FORCE ACADEMY

COLORADO SPRINGS, COLORADO 80840

31 April 1987

REPLY TO
ATTN OF: CW

SUBJECT: Common Item Acronym Reference System (CIARS)

to: 01-04 CGp/CC
01-40 CS/CC

In an effort to distinguish the USAF Academy from common civilian institutions, the CIARS program has been developed where common, everyday items have been assigned USAF-distinct acronyms. Effective ASAP, all cadets will refer to the following items as the acronyms listed below. Those found using old terminologies will be issued AFCW Form 10s. More CIARS acronyms will be published in future LOIs.

Library	Bound Documents/Academic Research Facility (BDARF)
Punishments	Negative Reinforcement Movement Curtailment Measures (NERMCUM)
Bathrobe	Pre/Post Hygienics Exposure Management Apparel (PHEMA)
Squadron Party	Local Organizational Unit Festivity (LOUFEST)
Message Board	Written Communications Transit Board (WCTB)
Overshoes	Waterproof Elastic Sho Protection Units (WESPU)
Spirit Hill	Elevated Terrazzo Motivational Geographic Feature (ETMGF)
Continental Breakfast	Experimental Dietary Control Meal (ECDM)
Tie Bar/Tac	Tie Apparel Free-end Retention Accessory (TAFERA)
Name Tag	Personal Surname Declaration Uniform Item (PSDUI)
Reg Party	Military Regulation Deletions/Additions/Changes Ceremony (MRDACC)
Slush Fund	Miscellaneous Financial Expenditures Treasury (MIFET)
Cheerleader	Massed Oral Motivation Acrobat (MOMA)
Buffer	Rotating Base Lipid Setter (RBLs)
Intramurals	Sportsmanship/Teamwork Enhancement/Development Tournaments (STEDT)
Passes	Installation Temporary Departure Authorizations (ITDA)
Cadet Store	Necessity/Convenience Goods Open Mart for Cadets (NCGOMC)
Trunk Room	Cadet Personal Property Long-Term Storage Chamber (CPPLSC)
Vacuum Cleaner	High Power Insignificant Carpeted Floor Material Suction Appliance (HIPICFMSAP)
Soap	Low Friction Coefficient Hygienic Cleansing Lipid Derivative (LFCHCLD)
Flight Cap	Army Overseas Cap Air Force Variant Headwear (AOCAFVH)
Phone	Wired Verbal Communications Terminal (WVCT)

USAFA LIFE CONSTANT AND EQUATIONS SHEET

LIFE GENERAL EQUATION: $Life = \int_{birth}^{death} (events) dt + C$

Value for C

Human Secularist: $C = 0$

Pro-lifer: $C = \int_{conception}^{birth} (events) dt$

Shirley McLaine $C = \sum (previous\ lives) + \sum (future\ lives)$

LIFE EQUATION FOR NIHILIST: $Life = Life(t=t) = Now$

LIFE EQUATION FOR CADET: $Life = \int_{Friday\ LMD}^{Sunday\ 2000\ HRS} (events) dt$

EXPONENTIAL EQUATION, GENERAL: $\int e^x = f(u)n!$

Note: This equation is an approximation. Sometimes $\int e^x = \Delta(Population)$
 where $Population = \sum(Life)$ at time t .

EXPONENTIAL EQUATION, FOR CADETS: $\int e^x = 0$

FIGMO FACTOR EQUATION: $F.F. = \frac{Days\ since\ last\ break}{Days\ until\ next\ break} + (7 - Days\ until\ Friday)$

+ $[(Days\ until\ graduation)_{t=0} - Days\ until\ Graduation]$

THE COMMANDANT'S SHUFFLE

by Philip Templin
(sung to the tune of the Chicago Bears'
"Superbowl Shuffle")

Chorus: "We are the Commandant's Shufflin' Crew
Shufflin' down, doin' it for you.
We're so bad, we know we're good,
Wasting your time like you knew we would.

You know we're just bustin' your fun,
Ruining lives for everyone.
We're not here to let you scruffle.
We're just here to do the Commandant's Shuffle."

Brig. Gen. Westbrook: "They call me Sammy and I'd like to say,
Having fun around here just ain't my way.
We had the goal since B.C.T.
To plague the Air Force Academy

With military drill and needless instruction;
We'll do anything for joy's corruption.
I'm not here to let you scruffle,
I'm just here to do the Commandant's Shuffle."

■ Col. Fry: "I'm Howie J. and this is P.M.T.,
Rockin' it live at the Academy.
Our staff's here to rap our rhyme,
To show how we can waste your time.

We're not doin' it because it's cruel,
We're just following the standard rule:
Whatever makes sense, or is rationally sound,
The way we see it, will have no ground."

Lt. Col. Lorenz: "It's Gary here and I'm Mr. Clean.
They call me 'Stone' 'cause I'm so mean.
With me around as First Group Comm,
I take the place of everyone's Mom.

So clean your room and polish your shoes,
Or you'll be singing the confinement blues.
Follow my orders and don't talk back.
Ya better watch out, ya got that, Jack?"

(Chorus, followed by Instrumental;
Group A.O.C.'s shuffle to front stage and break dance.
Associate A.O.C.'s dance in pairs by the microphones and sing
back-up vocals: "Uh-huh. Uh-huh. Uh-huh."
Commandant and Deputy Commandant break dance on the middle
platform as it rises above the others.)

(continued)

Major Crowe: "I'm Bill Crowe Jr., known as B.C.
My job's to catch what Gary don't see.
First Group's always done the best,
'Cause no one dares put me to test.

I might as well admit, while in front of the Comm:
I'm the one who really threw the shaving cream bomb.
So you'd better watch out and not mess with me,
Or your room, too, is history."

Lt. Col. Ainsworth: "I'm Loren C., known well by all.
I stick around until ac-call
Watching and tracking your every move,
That's how I jam my Commandant's groove.

As an A.O.C. I know I'm great,
Why else would I stay so late?
In Second Group we know we're cool.
Let's face it, ya'll, we love this school."

(Instrumental;

Smoke poors out onto the dance floor. Colored stagelights go
on, reflecting a subtle cadet-blue onto the background.
Strobe lights begin to flicker on the Commandant's elevated
platform. Ten beautiful women in swimsuits run out on
stage to adore, caress, and dance provocatively with the
Commandant's staff.)

Major Brown: "I'm Bobby Brown, Loren's buddy.
Second Group we watch and study.
Together we learn what dinks don't dig,
So now our threats are twice as big.

The mornings are Second Group's time of doom;
That's when I look at every room.
And if I find just one thing wrong,
Our open door policy's all day long."

Lt. Col. Davis: "My name's Richard and I'm the same.
My best tools are fear and shame.
I'll bust 'em and hit 'em any time of day;
I'll take the trouble-makers and make them pay.

From marble strip to carpeted hall,
I'm the baddest dude this side of the wall.
So just sit back and watch me chill,
As Third Group's dinks grow sad and ill."

(Chorus;

The smoke-filled stage now becomes the background for a
spectacular laser light show. The chorus of officers
sings heartily, as the Commandant reappears in a devil's
costume. Side-stage effects include bursting fire
fountains and sparklers. Acrobats jump, flip, and fling
their bodies across the stage.) (continued)

Major Manning: "I say Rich is a darn good man,
But if he can't do it, I sure can.
My name's Robby and it's no wonder,
I sting like lightning and roar like thunder.

Rich and I cover it down to the bone,
That's why they call us the 'Form 10 Zone.'
Come on, everybody, let's scream and yell,
We're gonna do the Shuffle and you'll feel swell."

Lt. Col. Smith: "I'm Robby O., Fourth Group's boss,
I'm the sole cause of major loss.
Hope you all know what the regulations are,
'Cause if you don't, I'll take your car.

Some say I'm a bit too cruel,
But ya gotta be tough to finish this school.
There's no one here who does it like me,
My Commandant's Shuffle will set you free."

Major Martin: "I help Robby keep control.
My name's Stephan and I'm on a roll:
Twenty Form 10's in just one week,
Wait until I find another information leak.

The chain of command we'll blatantly skip
Just to maintain our power trip.
We're not here to let you scruffle,
We're just here to do the Commandant's Shuffle."

(Instrumental;
followed by Chorus;

The floor separates at center stage and a giant Commandant's
wreath emerges from the gap. Bubbles float into the air
and the vocals fade out.)



JOE Strack

Comix



JOE TRIES TO GET A DATE

A short history of 'Joe Strack', for anyone who cares:
'Joe' was started around '79 or '80 by the then editor of Dodo Stu Pope. After he graduated, 'Joe' was taken over by an '85er named Rolando Alvarado-Avelan. 'Joe' was still real popular, so I picked him up in '85-'86 and kept him going-- "I" being Dave Butler, the editor (A.K.A. Grinch, or 8DOGS). I'm sure someone will pick him up next year, he's kind of an institution so far. Thanks, stu (wherever you are).

P.S.: All the back issues of Dodo are kept up in the archives section of the library if you want to go see them. -Ed.

REPLY TO
ATTN OF: DF

SUBJECT: NEW GRADUATION REQUIREMENT EXAMINATION (GRE) REQUIREMENTS.

TO: CLASS OF 1988 AND 1989.

1. It has been felt that the current curriculum offered has not been adequately preparing cadets for the demanding and widely varied roles of an officer in the United States Air Force. An officer, especially in the future, must be prepared to meet any crises and deal with any situation. Thus it is required that each person have a well rounded and thorough education and background in many areas.
2. For this reason, new standards have been set for graduation starting with the class of 1988 and all subsequent classes. This allows for adequate time for cadets to choose appropriate classes to prepare for the GRE.
3. A sample test has been provided in this letter to allow cadets to work on areas they feel they are weak in. The subjects of the questions are purposely widely varied and it is expected and required that all questions be answered fully and completely. This is a graduation requirement.
4. Each question is clearly and concisely worded. You may not, therefore, ask questions of the examiner. No exceptions will be made.
5. SAMPLE TEST INSTRUCTIONS: Read each question carefully. Answer all questions. Time limit: 4 hours. Begin immediately.
 - a. HISTORY: Describe the history of the papacy from its origins to the present day, concentrating especially but not exclusively, on its social, political, economic, religious and philosophical impact on Europe, Asia, America, and Africa. Be brief, concise, and specific.
 - b. MEDICINE: You have been provided with a razor blade, a piece of gauze and a bottle of Scotch. Remove your appendix. Do not suture until your work has been inspected. You have fifteen minutes.
 - c. PUBLIC SPEAKING: 2500 riot-crazed aborigines are storming the classroom. Calm them. You may use any ancient language except Latin or Greek.
 - d. BIOLOGY: Create Life. Estimate the difference in subsequent human culture if this form of life had developed 500 million years earlier, with special attention to its probable effect on the English parliamentary system. Prove your thesis.
 - e. MUSIC: Write a piano concerto. Orchestrate and perform it with flute and drum. You will find a piano under your seat.
 - f. PSYCHOLOGY: Based on your knowledge of their works, evaluate the emotional stability, degree of adjustment, and repressed frustrations of each of the following: Alexander of Aphrodisias, Rameses II, Gregory of Nicia, Hammurabi. Support your evaluation with quotations from each man's work, making appropriate references. It is not necessary to translate.
 - g. SOCIOLOGY: Estimate the sociological problems which might accompany the

end of the world. Construct an experiment to test your theory.

h. ENGINEERING: The disassembled parts of a highpowered rifle have been placed on your desk. You will also find an instruction manual, printed in Swahili. In 10 minutes a hungry Bengal tiger will be admitted to the room. Take whatever action you feel appropriate. Be prepared to justify your decision.

i. ECONOMICS: Develop a realistic plan for refinancing the national debt. Trace the possible effects of your plan in the following areas: Cubism, the Donatist controversy, the wave theory of light. Outline a method for preventing these effects. Criticize this method from all possible points of view. Point out the deficiencies in your point of view, as demonstrated in your answer to the last question.

j. POLITICAL SCIENCE: There is a red telephone on the desk beside you. Start World War III. Report at length on its socio-political effects if any.

k. EPISTEMOLOGY: Take a position for or against truth. Prove the validity of your stand.

l. PHYSICS: Explain the nature of matter. Include in your answer an evaluation of the impact of the development of mathematics on science.

m. PHILOSOPHY: Sketch the development of human thought, estimate its significance. Compare with the development of any other kind of thought.

n. GENERAL KNOWLEDGE: Describe in detail. Be objective and specific.

6. The actual GRE will have different but equivalent questions.

7. Start preparing today.



But sir,
he hit me!

THE
DODO
GRAD
GUIDE



The DODO proudly presents this guide for the newly-commissioned AFA Grad. This will help you to make all the necessary adjustments that accompany the transition from cadet to officer status.

If you inadvertently wake up at 6 a.m. (nobody says 0600), just go back to sleep. Real people never get up this early. No one will be calling minutes, so you will have to learn to use an alarm clock. As you are at least 21 years old, you don't have to go to breakfast if you don't want to. You may have a percolator in your room, and you may read at the table. You can even put two forearms or your elbows on the table. Clean up your room a little bit, even though nobody will inspect it, not even on Saturday.. There is no need to fold your underwear 6x6 anymore. Command Post won't tell you what to wear, so you must learn to decide for yourself. This will be difficult at first, but you will be surprised at how fast you catch on.

Since you are an officer now, you may park near where you live. Drive to work and be in place by contact time, since there is no first call or assembly. Whatever your job is, you will be forced to work with such unfortunates as Reserve Officers, Distinguished Military Graduates, and former West Pointers. Don't expect perfection from these men. Smile, flash your ring around the room, and act nice. Remember that you are a Grad and a "Career" Officer. If you are ever unsure about what to do, just remember your PMT lectures and you will be set.

There is no formation for lunch, you do not march, and you may miss the meal. Depending on where you are stationed, you may or may not be served family style. If you are not, play it by ear, watch the ROTC grads, and do what they do.. Do not make [redacted] with the Italian salad dressing. If you have a brand new jar of peanut butter, keep calm. Quietly open it and act as if it had been used before.

When your work is through, you will in all probability not have intramurals or drill, so the time is yours. You may take a non-chargeable ODP without signing out. This is just one of the many privileges that officers enjoy.

Nighttime will necessitate drastic adjustments. You have unlimited ONPs. You do not have to buff your floors at 1:30 in the morning. You can sleep between your covers. Actually, the night provides an excellent opportunity to utilize your AFA time management training, with one small difference being that you need not remain in your room all night. A last bit of advice--learn to enjoy the simple things in life...like sitting around listening to your hair grow.